

BiBox 104-I58 v.7 - Efficient 10.4 inch Panel Computer with 16GB RAM, 512GB SSD, i5-8250U, RS232, 2x LAN, Windows 11 Pro - For Control Systems and Network Integration

Category:	Industrial Panel PC Computers
Manufacturer:	Mobikator
Supported OS:	Windows
Installed OS:	Windows 11 PRO
Screen size:	10.4 inch
Resolution:	1024x768
Aspect ratio:	4:3
Brightness:	350 NIT
Touchscreen:	Capacitive
CPU Support:	---
Installed CPU:	Intel core i5-8250U
Graphic Card:	CPU Integrated graphics HD Graphicssupport 1080p HD photo quality
Storage (HDD) Support:	SSD
Installed Storage (HDD):	Dysk SSD 512 GB
Memory Support:	DDR4
Installed Memory:	16GB
IP Norm:	65

IP Level (front panel):	IP65
IP Level (back panel):	-----
Temp:	-10 °C to 60 °C
Storage Temp:	-20 °C to 70 °C
Humidity:	5% - 95% Non-Condensing
Anti-shock:	----
Anti-vibration:	5-500Hz,0.026G ² /Hz,2.16Grms,X,Y,Z1 hour per axis
Others:	WiFi (standard)
LAN:	2 ports
Wireless LAN card:	---
3G:	1x Mini-PCIE expansion slotsupport WIFI/3G/4G/MSTA/GPS
4G LTE:	Optional
Bluetooth:	Yes
GPS:	1x Mini-PCIE expansion slotsupport WIFI/3G/4G/MSTA/GPS
Ports - rear panel:	Ports USBx4 HDMIx1 VGAx0 LANx2 EARx1 RS232x2 MICx1 Power DC12V
Ports - front panel:	-----
Ports - left panel:	-----
Ports - right panel:	-----
Expansion:	---
Power:	Power DC12V
Power Consumption:	Power consumption: ≤60W
Watch Dog Timer:	---
Mounting VESA:	100 x 100 mm
Folding Bracket (for office type working):	-----
Chipset:	---
CD/DVD Drive:	No
Audio:	Realtek ALC662 High Definition Audio (HD)Line in Line out
TV Tuner:	No

Backlight MTBF:	---
Contrast Ratio:	800:1
Dual display:	HDMI
Viewing Angle:	80°/80°/75°/75°(R/L/U/D)
Touch Life(contacts):	---
Surface hardness (display):	---
Color Resolution:	---
Response time touch-panel (ms):	8 ms
Housing material:	---
Dimensions:	217.90 x 270.50 x 51.80 mm
Fanless:	---
Weight:	2.4 kg

3 178,01 zł

net price: 2 583,75 zł

BiBox 104-I58



CERTIFICATES

SPECIFICATION

RESISTANCE

COMMUNICATIONS AND CONNECTIONS

APPLICATION

ACCESSORIES AND AVAILABLE VERSIONS

The BiBox 104-I58 panel computer is a versatile device that combines the functions of a desktop computer and a touchscreen. Its design is adapted to operate in harsh industrial environments characterized by high humidity, dust, exposure to water, and extreme temperatures. This ensures high performance and operational stability regardless of environmental conditions.

CERTIFICATES



The BiBox 104-I58 computer panel has key CE, FCC, and RoHS certifications. These certifications ensure the device is safe to use (CE), does not interfere with other devices (FCC), and is free from harmful substances (RoHS). Obtaining these certifications confirms compliance with rigorous quality and environmental standards in force around the world. This ensures that the product is not only efficient and reliable but also completely safe for both the user and the environment. They guarantee that the manufacturer has met all necessary legal and technical requirements.

[up...](#)

[menu...](#)

SPECIFICATION

BiBox 104-I58 v.7	
Certifications	CE FCC RoHS
Network	1xRealtek RTL 8111E Gigabit Ethernet controller
Processor	Intel core i5-8250U
Graphics	CPU Integrated graphics HD Graphics and support 1080p HD photo quality
Operating system	Windows 11 PRO
Memory	16GB RAM + 512GB SSD
Display	10.4" (1024x768)
Touch screen	Capacitive
Viewangle	80°/80°/75°/75° (R/L/U/D)
Protection	IP65
Communication	WiFi (standard) BT 1x Mini-PCIE expansion slot support WIFI/3G/4G/MSTA/GPS
Connectors	1x MIC 4x USB 2x LAN 1x EAR 1x HDMI Power DC12V 2x RS232



Detailed device specification is available in the "Technical data".

The BiBox 104-I58 is a durable panel computer powered by an Intel Core i5-8250U processor. This powerful yet energy-efficient unit is ideal for industrial applications. Turbo Boost technology allows the processor to dynamically increase its frequency, allowing for smooth operation even with demanding applications. Its four cores and eight threads ensure high performance,

allowing for simultaneous processing of multiple tasks without slowing down the system.

[up...](#)

[menu...](#)

Dimensions

This panel computer measures 270.50 mm wide, 217.9 mm high, and 51.8 mm deep. Its compact, flat housing is designed to fit perfectly in control cabinets and confined industrial spaces. The panel is packed in a cardboard box, each containing three panel computers. This box has a gross weight (GW) of approximately 12 kg. Included inside the box are a power adapter and a Wi-Fi antenna.

Dimensions

270.50 x 217.9 x 51.8 mm

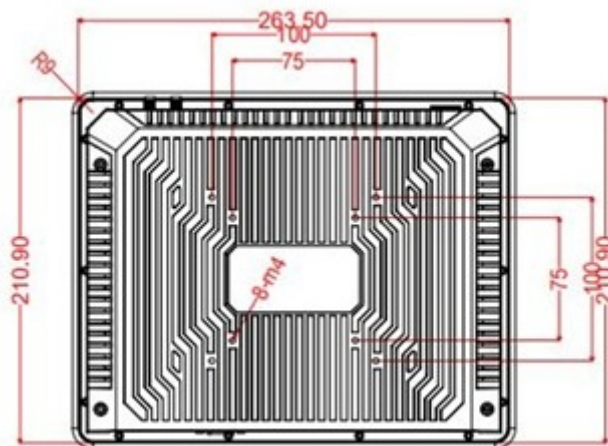

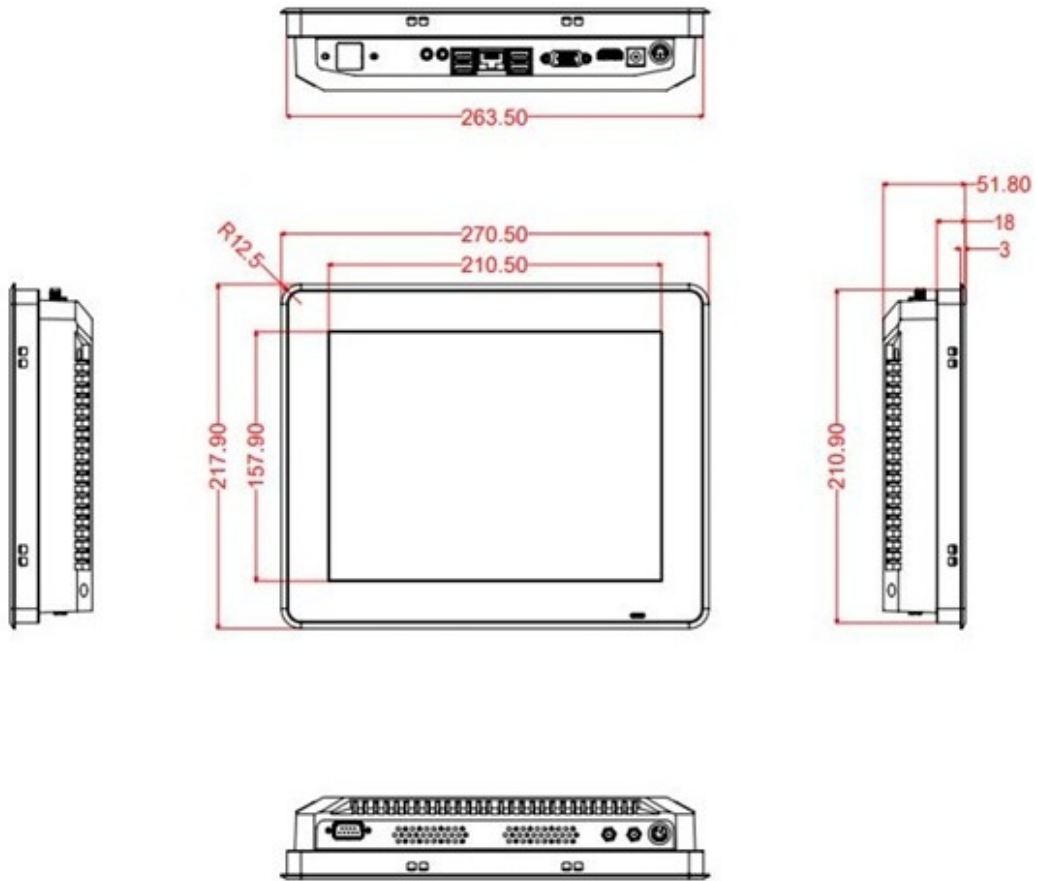

[up...](#)

[menu...](#)

Capacitive screen



A capacitive screen detects touch by changing the electrostatic field created when you touch the screen with your finger. Unlike resistive technology, it doesn't require any physical pressure. This makes operation precise and fluid, with the screen responding to even the lightest touches. This technology also supports multitouch, allowing for simultaneous recognition of multiple touch points, enabling gestures such as zooming or rotating.

Aluminium Bezel Style



ALUMINIUM BEZEL STYLE

The Aluminium Bezel Style design means that the device's screen frame is made of aluminium or has an aluminium finish. The primary purpose of this design is to give the device a premium look and feel, as aluminium is significantly more durable and rigid than standard plastic. Besides its aesthetic appeal and luxurious finish, the aluminium bezel provides better protection against scratches and damage, and also dissipates heat more efficiently. Furthermore, aluminium's lightweight nature allows for a slim profile without compromising structural strength.

***At the customer's request, it is possible to order the BiBox 104-I58 device in the Aluminum Bezel Style version. Click on the configurator at the top of the page to go to the product settings.**



350-nits screen



The BiBox 104-I58 panel is ideal for outdoor use, and its 350-nit screen provides good visibility in shaded areas or in moderate sunlight. This allows for comfortable use without any readability issues.

[up...](#)





[menu...](#)





RESISTANCE

IP65

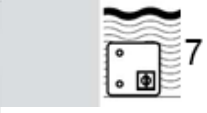

The IP65 standard means that the device's housing provides complete protection against dust ingress. It is also resistant to water jets from any direction. This makes it an ideal solution for use in harsh environments where the equipment is exposed to external factors but not immersed in water.

Firts digit	Protection level	Second digit
No special protection	0  0	No special protection
Protection from solid objects greater than 50mm in diameter	1  1	Protection from dripping water
Protection from object not greater than 12mm in diameter	2  2	Protection from vertically dripping water (tilted up to 15°)
Protection from object not greater than 2,5mm in diameter	3  3	Protection from sprayed water (tilted up to 60°)
Protection from object not greater than 1mm in diameter	4  4	Protection from splashed water

Firts digit	Protection level	Second digit
Complete protection against contact, Protection against dust deposit		Protection from water projected from a nozzle
Complete protectionm against contact, protection from infiltration of dust		Protection against heavy seas, or powerful jets of water
		Protection against immersion
		Protection against complete, continuous submersion in water

Extreme temperatures

The ruggedized BiBox 104-I58 is built to withstand the most demanding conditions. Designed to operate in a wide temperature range (-10°C to 60°C), it is also resistant to relative humidity up to 95% (non-condensing). It can also be safely stored in extreme temperatures ranging from -20°C to 70°C.

Working Temp.	-10°C do 60°C
Storage Temp.	-20°C do 70°C
Humidity	5% do 95%

[up...](#)

[menu...](#)

COMMUNICATIONS AND CONNECTIONS

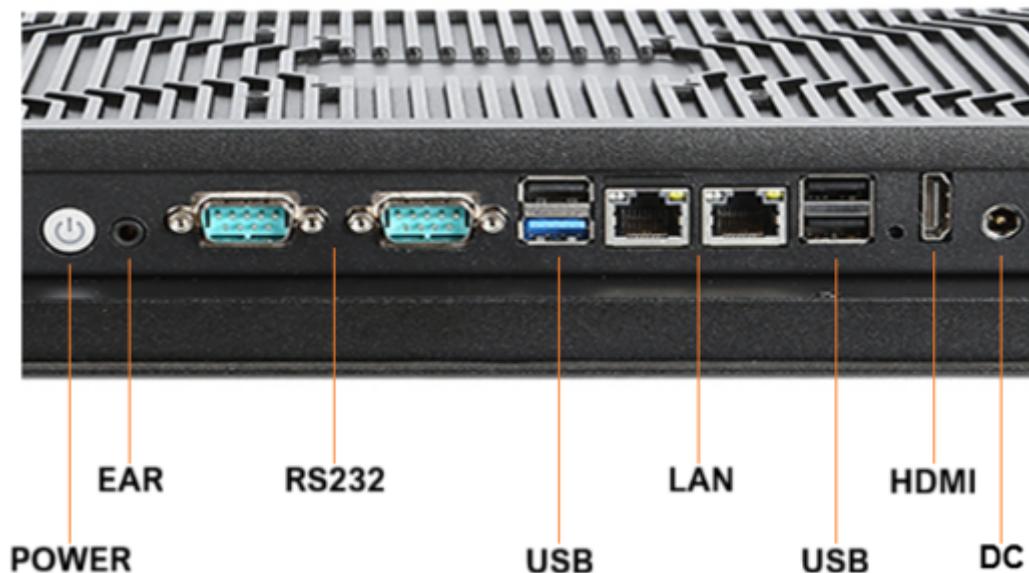

Communication

The device features a single Mini-PCIe expansion slot, which serves as a universal port for installing additional modules. This slot can accommodate, for example, a Wi-Fi card for wireless internet connection, a 3G/4G module for cellular connectivity, or an mSATA drive for memory expansion. This feature allows the device to be easily customized to meet specific needs and applications.

Ports

The BiBox 104-I58 is equipped with four USB ports, one HDMI port, and two LAN ports. It also has audio ports, including a microphone input (MICx1) and a headphone output (EARx1). Two RS-232 serial ports are available for industrial communication. The device does not have a VGA port and is powered by 12V DC.

APPLICATION

The BiBox 104-I58 Panel PC is ideal for retail environments, where it can control point-of-sale systems, display product information, and present advertisements on monitors. Compliant with the VESA mounting standard, the device can be easily mounted in various locations, such as at cash registers, in factory halls, or in delivery vehicles. This versatile solution will find its place in any retail chain.



[do góry...](#)

[menu...](#)

Industry and Construction

Specialized panel computers are reliable tools for use in the harshest environments. Their enclosures are resistant to dust and powerful water jets, as certified by the IP65 standard. This makes devices like the BiBox 104-I58

ideal for applications in construction, logistics, and manufacturing—anywhere where traditional equipment would quickly fail. This is durability you can rely on.

Warehouse

Thanks to its RS-232 interface, this industrial panel computer can be used to centrally control warehouse devices, significantly streamlining their operation. Its durable housing is ideally suited to harsh industrial environments. The device is resistant to dust and dirt, ensuring reliable operation even in highly polluted environments.



[up...](#)

[menu...](#)

ACCESSORIES AND AVAILABLE VERSIONS

The BiBox 104-I58 industrial panel computer is available in several versions tailored to various needs. Clicking on the hardware configuration number will redirect you to the product with the parameters listed in the table below. Furthermore, upon request, we can create a configuration not currently available in our offer.



More photos in full resolution available in the "Gallery".

	v.1	v.2	v.3	v.4	v.5	v.6	v.7	v.8
Windows 11 PRO	-	+	-	-	+	+	+	+
1000 NIT	-	-	-	+	-	+	-	+
8GB + 128GB	+	+	-	-	-	-	-	-
8GB + 256GB	-	-	+	+	+	+	-	-
16GB + 512GB	-	-	-	-	-	-	+	+
4G	-	-	-	-	-	+	-	-
WiFi 6	-	-	-	-	-	+	-	-