



BiBox 121-I58 v.3 - 12.1 inch Panel Computer with Intel i5-8250U, 8GB RAM, 256GB SSD, 2x RS232, 2x RJ45 - Professional device for logistics, warehouses and distribution centers

Category:	Industrial Panel PC Computers
Manufacturer:	Mobikator
Supported OS:	Windows
Installed OS:	Windows 10 protest version(optional - licensed SYSTEM)
Screen size:	12.1 inch
Resolution:	1024x768
Aspect ratio:	4:3
Brightness:	350 NIT
Touchscreen:	Capacitivewith anti glare - Optional
CPU Support:	---
Installed CPU:	I5-8250U Fanless
Graphic Card:	CPU Integrated graphics HD Graphicssupport 1080p HD photo quality
Storage (HDD) Support:	SSD
Installed Storage (HDD):	Dysk SSD 256 GB
Memory Support:	DDR4
Installed Memory:	8GB
IP Norm:	65

IP Level (front panel):	IP65
IP Level (back panel):	-----
Temp:	-10 °C to 60 °C
Storage Temp:	-20 °C to 70 °C
Humidity:	5% - 95% Non-Condensing
Anti-shock:	----
Anti-vibration:	5-500Hz,0.026G ² /Hz,2.16Grms,X,Y,Z1 hour per axis
Others:	WiFi (standard)
LAN:	2 ports
Wireless LAN card:	---
3G:	2x Mini-PCIE expansion slotsupport WIFI/3G/4G/MSTA/GPS
4G LTE:	Optional
Bluetooth:	Yes
GPS:	2x Mini-PCIE expansion slotsupport WIFI/3G/4G/MSTA/GPS
Ports - rear panel:	Ports USBx4 HDMIx1 VGAx0 LANx2EARx1 RS232x2 MICx1 Power DC12V
Ports - front panel:	-----
Ports - left panel:	-----
Ports - right panel:	-----
Expansion:	---
Power:	Power DC12V
Power Consumption:	Power consumption: ≤60W
Watch Dog Timer:	---
Mounting VESA:	100 x 100 mm
Folding Bracket (for office type working):	-----
Chipset:	---
CD/DVD Drive:	No
Audio:	Realtek ALC662 High Definition Audio (HD)Line in Line out
TV Tuner:	No

Backlight MTBF:	---
Contrast Ratio:	800:1
Dual display:	HDMI
Viewing Angle:	85°/85°/85°/85°(R/L/U/D)
Touch Life(contacts):	Touch Pen Hitting Life >=1 milions times
Surface hardness (display):	---
Color Resolution:	---
Response time touch-panel (ms):	8 ms
Housing material:	---
Dimensions:	294.2 x 232.7 x 51.8mm
Fanless:	Yes
Weight:	3.5kg

2 689,09 zł

net price: 2 186,25 zł

BiBox 121-I58



CERTIFICATES

SPECIFICATION

RESISTANCE

COMMUNICATIONS AND CONNECTIONS

APPLICATION

ACCESSORIES AND AVAILABLE VERSIONS

The BiBox 121-I58 is a reliable panel computer combining the power of a desktop PC with an intuitive touchscreen. Designed for the most demanding industrial environments, it performs reliably in conditions of high humidity, dust, water exposure, and extreme temperatures, ensuring stability and high performance.

CERTIFICATES



The BiBox 121-I58 offers not only performance but also a guarantee of safety. Key CE, FCC, and RoHS certifications confirm its compliance with global standards: safe use (CE), no interference with other devices (FCC), and freedom from harmful substances (RoHS). You can be sure that this is a reliable product, safe for you and the environment, and meets all necessary legal and technical requirements.

[up...](#)

[menu...](#)

SPECIFICATION

BiBox 121-I58 v.3

Certifications	CE FCC RoHS
Network	1× Realtek RTL 8111E Gigabit Ethernet controller
Processor	I5-8250U Fanless
Graphics	CPU Integrated graphics HD Graphics and support 1080p HD photo quality
Operating system	Windows 10 pro test version (optional - licensed SYSTEM)
Memory	8GB RAM + 256GB SSD
Display	12.1" (1024x768)
Touch screen	Capacitive
View angle	85°/85°/85°/85° (R/L/U/D)
Protection	IP65 (front panel)
Communication	WiFi (standard) BT 2x Mini-PCIE expansion slot support WIFI/3G/4G/MSTA/GPS
Connectors	1x MIC 4x USB 2x LAN 1x EAR 1x HDMI Power DC12V 2x RS232



Detailed device specification is available in the "Technical data".

The BiBox 121-I58 is a robust panel computer powered by the I5-8250U Fanless processor. This powerful yet energy-efficient unit is ideal for industrial applications. Its fanless design ensures silent operation and eliminates the risk of dust-related malfunctions. Four cores and eight processor threads ensure high performance, allowing for simultaneous processing of multiple tasks without system slowdown.

up...

Dimensions

The BiBox 121-I58 panel computer measures 294.2 mm wide, 232.7 mm high, and 51.8 mm deep. Its compact, flat housing is designed to fit perfectly into control cabinets and confined industrial spaces. The device is packaged in cartons containing two panel PCs. The total gross weight (GW) of one such package is approximately 9.5 kg. Included accessories for these two devices include power adapters and Wi-Fi antennas.

Dimensions

294.2 x 232.7 x 51.8mm

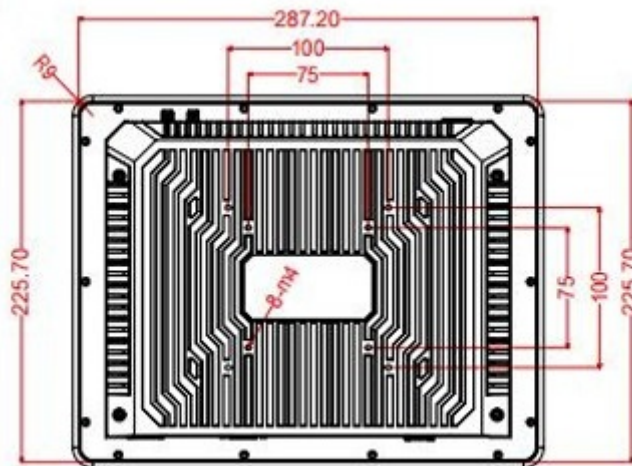

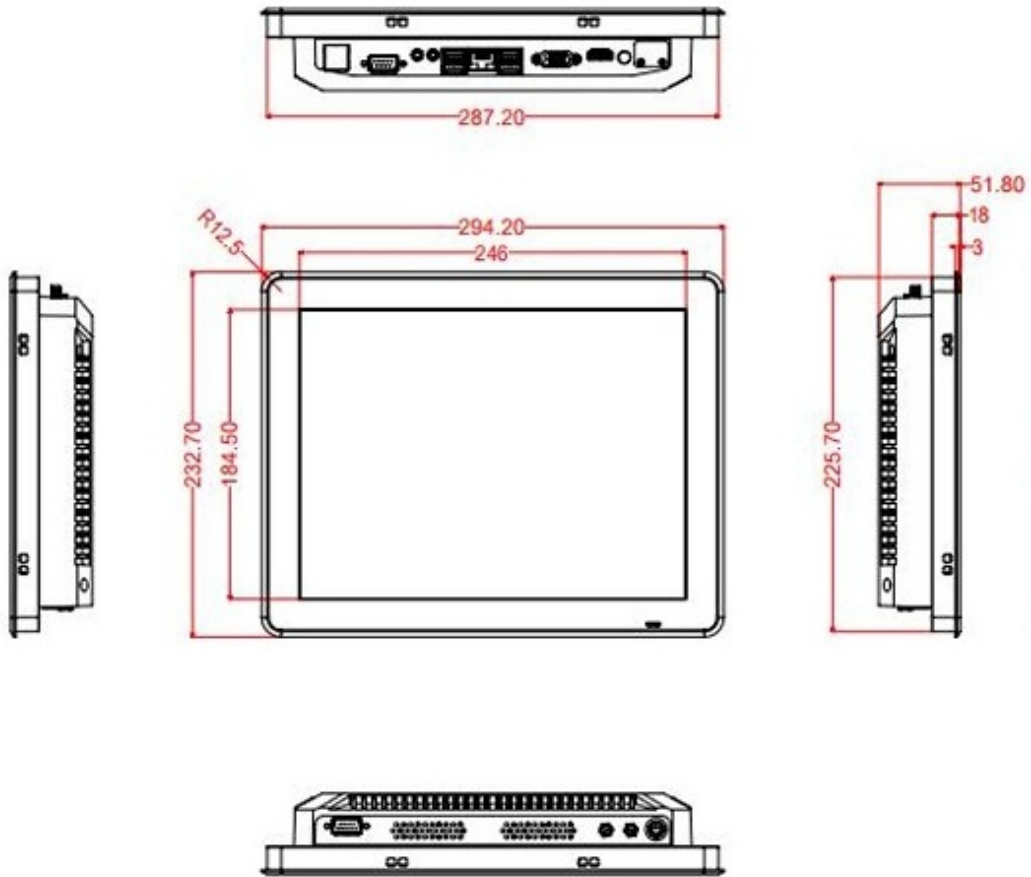

[up...](#)

[menu...](#)

Capacitive screen



A capacitive screen detects touch by changing the electrostatic field created when you touch the screen with your finger. Unlike resistive technology, it doesn't require any physical pressure. This makes operation precise and fluid, with the screen responding to even the lightest touches. This technology also supports multitouch, allowing for simultaneous recognition of multiple touch points, enabling gestures such as zooming or rotating.

Aluminium Bezel Style



ALUMINIUM BEZEL STYLE

The Aluminium Bezel Style design means that the device's screen frame is made of aluminium or has an aluminium finish. The primary purpose of this design is to give the device a premium look and feel, as aluminium is significantly more durable and rigid than standard plastic. Besides its aesthetic appeal and luxurious finish, the aluminium bezel provides better protection against scratches and damage, and also dissipates heat more efficiently. Furthermore, aluminium's lightweight nature allows for a slim profile without compromising structural strength.

***At the customer's request, it is possible to order the BiBox 121-I58 device in the Aluminum Bezel Style version. Click on the configurator at the top of the page to go to the product settings.**



350-nits screen



Designed for outdoor use, the BiBox 121-I58 panel computer offers excellent visibility. Its 350-nit screen effectively handles moderate sunlight and shadows, allowing for comfortable work without data readability issues.

[up...](#)





[menu...](#)





RESISTANCE

IP65

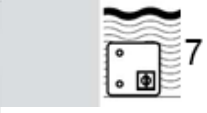

The IP65-compliant housing guarantees complete protection against dust and resistance to water jets from any direction. This makes the device ideal for harsh industrial environments where it is exposed to external factors but not immersion.

Firts digit	Protection level	Second digit
No special protection	0  0	No special protection
Protection from solid objects greater than 50mm in diameter	1  1	Protection from dripping water
Protection from object not greater than 12mm in diameter	2  2	Protection from vertically dripping water (tilted up to 15°)
Protection from object not greater than 2,5mm in diameter	3  3	Protection from sprayed water (tilted up to 60°)
Protection from object not greater than 1mm in diameter	4  4	Protection from splashed water

First digit	Protection level	Second digit
Complete protection against contact, Protection against dust deposit		Protection from water projected from a nozzle
Complete protection against contact, protection from infiltration of dust		Protection against heavy seas, or powerful jets of water
		Protection against immersion
		Protection against complete, continuous submersion in water

Extreme temperatures

The BiBox 121-I58 ruggedized panel computer is built to withstand the most demanding environmental conditions. It guarantees reliable operation across a wide operating temperature range, from -10°C to 60°C. It is also resistant to high relative humidity, tolerating a range of 5% to 95% (measured at 40°C), with non-condensing conditions crucial. Furthermore, its rugged design allows for safe storage in extreme temperatures, from -20°C to 70°C, ensuring its readiness for use even after extended periods of inactivity.

Working Temp.	-10°C do 60°C
Storage Temp.	-20°C do 70°C
Humidity	5% do 95%

[up...](#)

[menu...](#)

COMMUNICATIONS AND CONNECTIONS

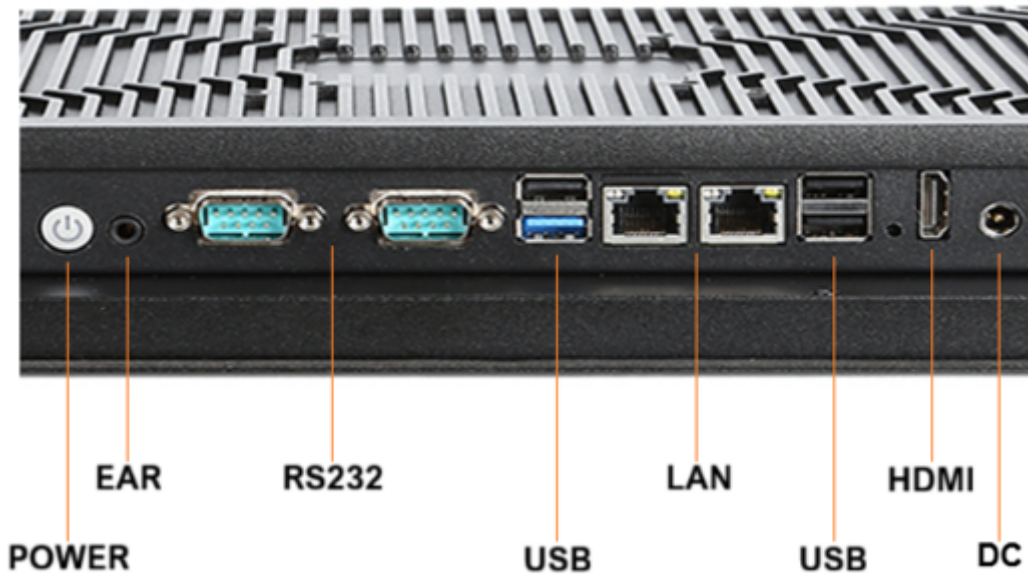

Communication

The BiBox 121-I58 panel computer offers exceptional flexibility thanks to its dual Mini-PCIe expansion slots. These versatile ports allow for the simultaneous installation of two additional modules, fully customizing the computer to meet the specific needs of industrial applications. Users can install, for example, a Wi-Fi card for wireless network connectivity, a 3G/4G module for always-on cellular connectivity, a GPS module for location tracking, or an mSATA drive for storage expansion. These dual slots allow the device to easily add key communication and storage capabilities.

Ports

The BiBox 121-I58 industrial panel computer is equipped with four USB ports, one HDMI port, and two LAN ports. It also features audio ports, including a microphone input (MICx1) and a headphone output (EARx1). Two RS-232 serial ports are used for industrial communication. The device does not have a VGA port and is powered by 12V DC.

APPLICATION

Trade and Services

The BiBox 121-I58 panel PC for special applications is ideal for retail environments, where it can control point-of-sale systems, display product data, or display advertising on monitors. Compliant with the VESA mounting standard, the device can be easily mounted in various locations, such as at sales counters, in factories, or in delivery trucks. This robust and versatile solution will find its place in any retail chain.



[do góry...](#)

Industry and Construction

Advanced panel computers are reliable tools for use in the harshest environments. Their enclosures are exceptionally resistant to dust and powerful water jets, as certified by the IP65 standard. This makes devices like the BiBox 121-I58 ideal for applications such as construction, transportation, and manufacturing – anywhere traditional equipment would quickly fail.

Warehouse

This industrial panel computer is a warehouse control center. Equipped with two RS-232 ports, it enables centralized control and coordination of various devices, significantly optimizing logistics processes. Its durable, dust- and dirt-resistant housing ensures reliable operation even in the most polluted industrial environments.



ACCESSORIES AND AVAILABLE VERSIONS

The BiBox 121-I58 industrial panel computer is available in several versions tailored to various needs. Clicking on the hardware configuration number will redirect you to the product with the parameters listed in the table below. Furthermore, upon request, we can create a configuration not currently available in our offer.

 More photos in full resolution available in the "Gallery".

	v.1	v.2	v.3	v.4	v.5	v.6	v.7	v.8
Windows 11 PRO	-	+	-	-	+	+	+	+
1000 NIT	-	-	-	+	-	+	-	+
8GB + 128GB	+	+	-	-	-	-	-	-
8GB + 256GB	-	-	+	+	+	+	-	-
16GB + 512GB	-	-	-	-	-	-	+	+
4G	-	-	-	-	-	+	-	-
WiFi 6	-	-	-	-	-	+	-	-