



BiBox 156-I58 v.7 - Professional 15.6-inch panel computer, 1920x1080 screen, Intel i5-8250U, 16GB RAM, 512GB SSD, RS232 x2, LAN x2, Windows 11 Pro, IP65 - For petrochemical industry and refineries

<b>Category:</b>	Industrial Panel PC Computers
<b>Manufacturer:</b>	Mobilator
<b>Supported OS:</b>	Windows 11, Windows 10, linux
<b>Installed OS:</b>	<b>Windows 11 Pro</b>
<b>Screen size:</b>	15.6"
<b>Resolution:</b>	1920X1080
<b>Aspect ratio:</b>	16:9
<b>Brightness:</b>	250 nits
<b>Touchscreen:</b>	Capacitive (10-points)
<b>CPU Support:</b>	4x max. 3.4 GHz Turbo, 8 threads
<b>Installed CPU:</b>	Intel Core i5-8250U
<b>Graphic Card:</b>	CPU Integrated graphics card Intel HD graphics
<b>Storage (HDD) Support:</b>	SSD
<b>Installed Storage (HDD):</b>	512GB SSD
<b>Memory Support:</b>	DDR4
<b>Installed Memory:</b>	16GB RAM
<b>IP Norm:</b>	65 (front)
<b>IP Level (front panel):</b>	IP65
<b>IP Level (back panel):</b>	None

<b>Temp:</b>	-20°C to 70 °C
<b>Storage Temp:</b>	-10°C do 70°C
<b>Humidity:</b>	5% - 95% Non-Condensing
<b>Anti-shock:</b>	No
<b>Anti-vibration:</b>	5-500Hz,0.026G <sup>2</sup> /Hz,2.16Grms,X,Y,Z1 hour per axis
<b>Barcode reader:</b>	No
<b>RFID scanner (reader):</b>	No
<b>Others:</b>	No
<b>LAN:</b>	2×Realtek RTL 8111H Gigabit Ethernet
<b>Wireless LAN card:</b>	<b>WiFi (standard)</b>
<b>3G:</b>	No, (option)
<b>4G LTE:</b>	No, (option)
<b>Bluetooth:</b>	<b>Bluetooth</b>
<b>GPS:</b>	No
<b>Ports - rear panel:</b>	2xUSB 2.0   2xUSB 3.0   1xHDMI   1xVGA   2xLAN   1xEAR   1xMIC Power DC12V, 9-36V (option)   4xRS232 (option) 2xRS232 1xRS485 (option) [instead of 1xRS232] 1xRS422 (option) [instead of 1xRS232]
<b>Ports - front panel:</b>	No
<b>Ports - left panel:</b>	No
<b>Ports - right panel:</b>	No
<b>Expansion:</b>	No
<b>Power:</b>	External PowerSupply AC100-240VWorking voltage DC12V, 9-36V (option) Power consumption ≤60W
<b>Power Consumption:</b>	---
<b>Watch Dog Timer:</b>	Yes
<b>Mounting VESA:</b>	100 x 100 mm   75mm x 75mm
<b>Folding Bracket (for office type working):</b>	No, (opcja)
<b>Chipset:</b>	Intel 300 series (Sunrise Point-LP)
<b>CD/DVD Drive:</b>	No

<b>Audio:</b>	Realtek ALC662   High Definition Audio (HD)Line in   Line out
<b>TV Tuner:</b>	No
<b>Backlight MTBF:</b>	No
<b>Contrast Ratio:</b>	1000:1
<b>Dual display:</b>	Nie
<b>Viewing Angle:</b>	85°/85°/85°/85°(L/R/U/D)
<b>Touch Life(contacts):</b>	---
<b>Surface hardness (display):</b>	7H
<b>Color Resolution:</b>	16.7M
<b>Response time touch-panel (ms):</b>	15 ms
<b>Housing material:</b>	Narrow Bezel Style, (option - Aluminum Bezel Style
<b>Dimensions:</b>	392.2 x 242.2 x 51.8 mm
<b>Fanless:</b>	No
<b>Weight:</b>	4.3kg

**3 477,83 zł**  
net price: 2 827,50 zł

## BiBox 156-I58



## SPECIFICATION AND PARAMETERS

## DISPLAY AND TOUCH

## HOUSING

## CONNECTORS AND COMMUNICATION

## RESISTANCE AND PROTECTION

## APPLICATION

## AVAILABLE VERSIONS AND ACCESSORIES

The PC 156-I58 industrial panel is a multi-tasking device combining the functions of the touch screen and a PC. The construction is adapted to difficult conditions and is resistant to extremely low and high temperatures, high humidity, contact with water and high levels of dust. The characteristics of these panels are primarily operational stability in various conditions and high efficiency.

## SPECIFICATION AND PARAMETERS

Performance	
Processor	Intel Core i5-8250U [4 rdzenie, 8 wątków, 1.6GHz/turbo 3.4GHz]
Graphics card	Integrated graphics Intel HD Graphics
Operating systemy	Windows 11 Pro

Performance	
RAM	16GB DDR4
Drive	512GB SSD
Display	
Screen	15.6", 1920x1080
Touch screen	Capacitive (10-points)
Brightness	250cd/m <sup>2</sup> , 1000cd/m <sup>2</sup> <b>*optional</b>
Screen ratio	16:9
View angle	89/89/89/89(R/L/U/D)
Interfaces	
Communication	WiFi (standard)   WiFi 6 <b>*optional</b> Bluetooth    4G <b>*optional</b>  2xMini-PCIe expansion slot
Connectors	2xUSB 3.0   2xUSB 2.0   1xHDMI 2xLAN   1xEAR   1xMIC 4xCOM <b>*optional</b>   DC 12V, 9-36V <b>*optional</b> 2xRS232 1xRS485 <b>*optional</b> (instead of 1xRS232) 1xRS422 <b>*optional</b> (instead of 1xRS232)
Other	
Dimensions	392.2 x 243.3 x 51.8 mm
Weight	4.3 kg
Casing material	Metal [Narrow Bezel Style] Aluminium [Aluminium Bezel Style] <b>*optional</b>

\* Optional equipment, available only in specific versions of the device or as customer's request



Detailed device specification is available in the "Technical data".

The heart of the BiBox 156-I58 is the Intel Core i5-8250U processor, which is both high-performance and energy-saving. Processing multiple tasks simultaneously is facilitated by four processor cores working together. Given the current load, the shared cache hierarchy (with multiple levels) dynamically allocates resources to each core. Hyper-Threading technology allows one core to support two threads, increasing overall performance. This shortens memory access. Integrated Intel UHD Graphics in the processor allows you to display images in 1080p, up to 4K resolution on various interfaces such as HDMI or DisplayPort.

up...

menu...

## DISPLAY AND TOUCH



## Capacitive screen



The device uses capacitive screen technology, which does not require physical pressure on the screen surface. Instead, it detects a change in the electrostatic field caused by a touch of a finger. Thanks to this solution, panel operation becomes very precise and smooth, allowing you to respond to even the softest finger swings. This technology allows interaction with devices in a natural and intuitive way, increasing user comfort even in difficult industrial conditions where precision and durability are extremely important.

## 250-nit screen



The BiBox 156-I58 panel is equipped with a screen with a brightness of 250 nits, which ensures high readability both in low light conditions and in outdoor environments. The design of the display allows for effective operation. As a result, the user uses the device with comfort and without losing the readability of the displayed information.

up...

menu...

## HOUSING

### Dimensions

The compact, flat BiBox 156-I58 PC panel housing was created to perfectly match control cabinets and small spaces in the industry. Its dimensions are 392.2 mm wide, 242.2 mm high and 51.8 mm deep.

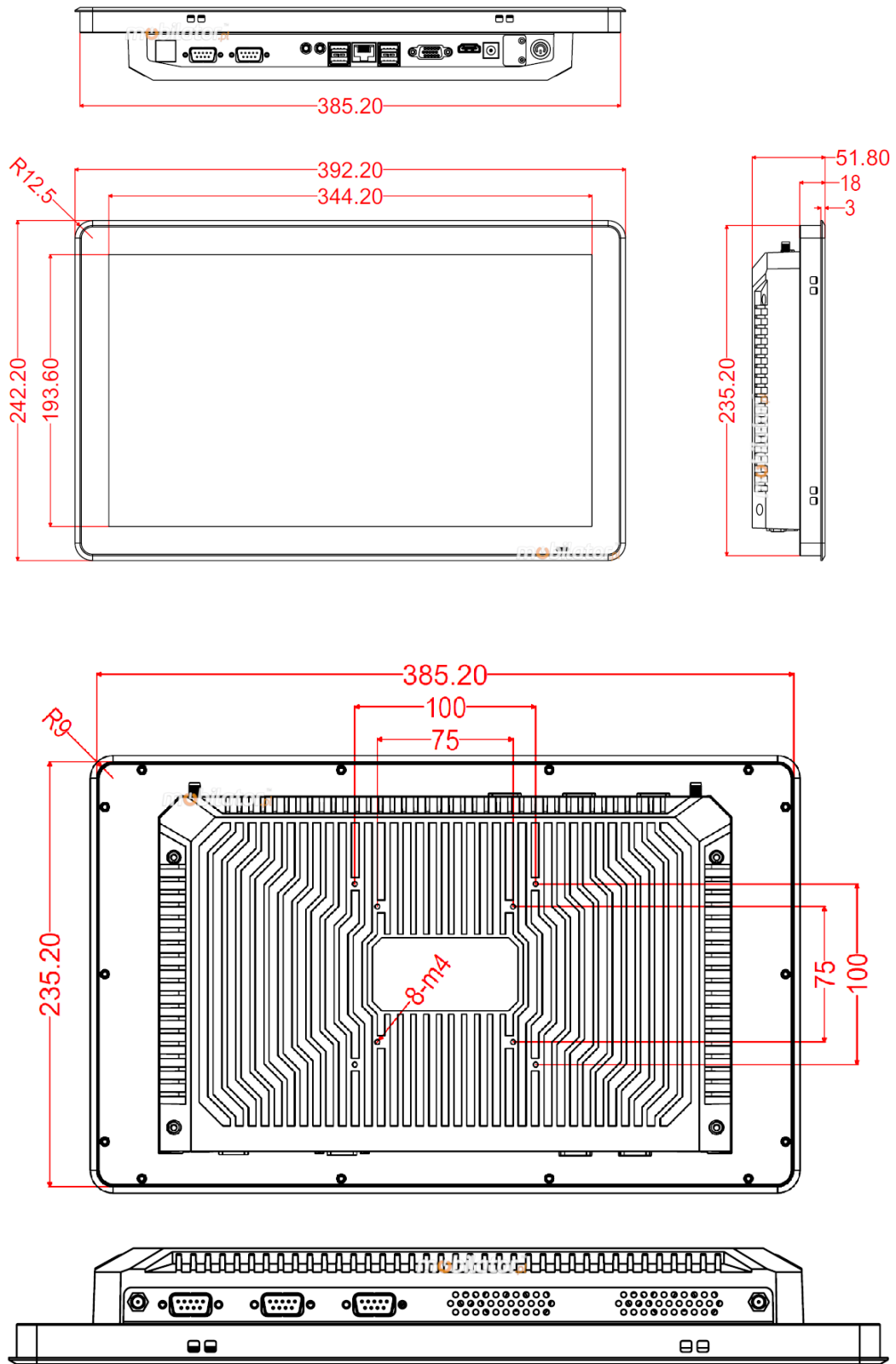

**Dimensions**

392.2 x 242.2 x 51.8 mm

## Narrow Bezel Style



The Narrow Bezel Style presented in the BiBox 156-I58 panel construction is a clearly narrow metal frame surrounding the screen. This housing gives the panel a professional look, emphasizing modern design and solidity while maintaining a light structure. It perfectly protects the screen against mechanical damage and efficiently dissipates heat, which has a positive effect on the life of components. This style is often used in PC panels for industrial applications and modern commercial interiors, emphasizing the

prestige of the device and ensuring excellent working conditions even in the multi-screen configurations.

Aluminum Bezel Style (optional)



The Aluminum Bezel Style visible in the photo is distinguished by minimalist narrow, slim, precisely made frame surrounding the screen, manufactured of durable aluminum. This housing guarantees the highest level of durability, resistance to mechanical damage and not only high stiffness, but also ensures effective heat resistance, which is crucial for the durability and stability of the device. This solution not only offers a large display area, combining elegance with modern

design, but also ensures durability and scratch resistance.

\* At the customer's request, it is possible to order the BiBox 156-I58 device in the Aluminium Bezel Style version. To select this finishing material, use the configurator located at the top of this page.

Installation method for a recessed housing for:

Narrow Bezel Style and Aluminium Bezel Style.







Apart from the recessed mounting type, the panel can be mounted on a standard VESA bracket.

[up...](#)

[menu...](#)

## CONNECTORS AND COMMUNICATION

### Connectors and ports

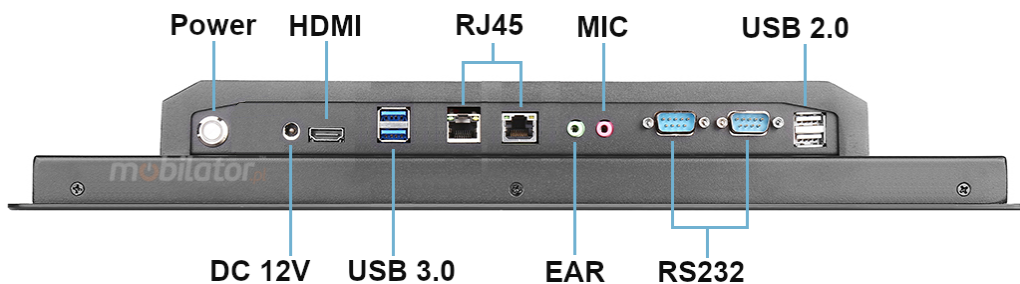

This device is equipped with four USB ports, two LAN ports, one HDMI input. In addition, the panel has audio connectors, including one MIC input and an EAR headphone input. We have two RS232 ports for industrial communication.

### Communication

The device is equipped with two universal Mini-PCIe expansion socket, which enables the integration of additional functional modules. A WiFi card for wireless network access, a 3G/4G module for cellular connectivity, or an mSATA disk for storage expansion can be installed in this port. With this option, it is possible to individually adapt the equipment to specific user requirements and specific industrial applications.

### RESISTANCE AND PROTECTION



Full leakproofness of the front of the panel ensures that no dust enters the device, which is confirmed by the degree of protection specified as IP65 standard. The equipment is protected from dust, so it can operate without interruption even in dusty environments. Additionally, the panel is resistant to water in the form of splashing streams, without causing any adverse effects. Water directed to the front of the built-up panel will not disturb the proper functioning of the equipment, which allows it to be used in difficult environmental conditions.









[up...](#)

[menu...](#)

Firts digit

Protection level

Second digit

No special protection	0  0	No special protection
Protection from solid objects greater than 50mm in diameter	1  1	Protection from dripping water
Protection from object not greater than 12mm in diameter	2  2	Protection from vertically dripping water (tilted up to 15°)
Protection from object not greater than 2,5mm in diameter	3  3	Protection from sprayed water (tilted up to 60°)
Protection from object not greater than 1mm in diameter	4  4	Protection from splashed water
Complete protection against contact, Protection against dust deposit	5  5	Protection from water projected from a nozzle
Complete protection against contact, protection from infiltration of dust	6  6	Protection against heavy seas, or powerful jets of water
	 7	Protection against immersion
	 8	Protection against complete, continuous submersion in water

Extreme temperatures

**Operation temperature ~ -20°C – 70°C**

**Storage temperature ~ -30°C – 80°C**



The BiBox 156-I58 device has been designed to operate in demanding environmental conditions. It is characterized by the ability to operate in a wide temperature range from -20°C to 70°C and high resistance to relative humidity up to 95%, in the absence of condensation. Additionally, the equipment can be safely stored at extreme temperatures, from -30°C to 80°C, ensuring reliability in various operating conditions.

<b>Operation temp.</b>	-20°C do 70°C
<b>Storage temp.</b>	-20°C do 80°C
<b>Humidity</b>	5% to 95%

up...

menu...

## APPLICATION

## Trade and services

The PC 156-I58 panel is widely used in the commercial sector, where it serves as a central sales control system, displaying product information and presenting advertisements on monitors. The device is compliant with the VESA mounting standard, which allows for easy installation in various places, such as cash register stations, production halls and the interiors of delivery vehicles. Thanks to these features, the BiBox 156-I58 panel is a universal and versatile platform, adapted to the requirements of modern commercial network.

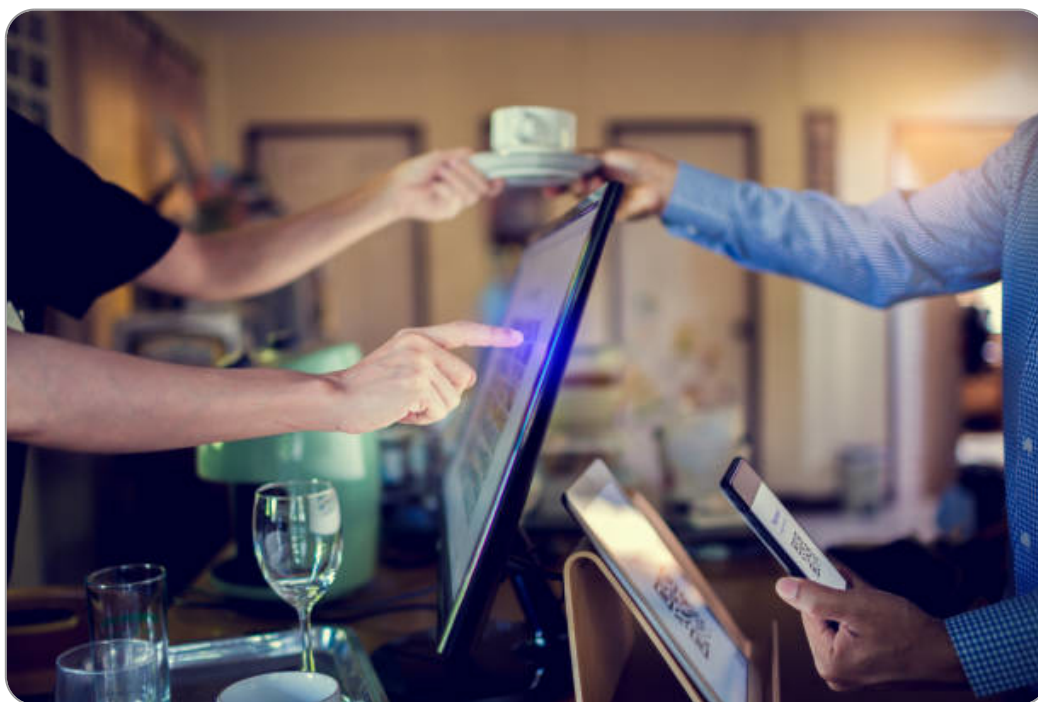

up...

menu...

## Industry and Construction

Panel computers for specialized purposes are characterized by high durability and reliability, thanks to which they can be used in environments with strict operating conditions. Their design has been carefully designed to provide full protection against dust and

resistance to water in the form of strong streams, which is confirmed by the IP65 certificate. This type of equipment, works perfectly in sectors such as construction, logistics and production lines, where conventional devices often fail quickly. Such durability guarantees stable and failure-free operation even in extreme conditions.



### Warehouse and management

An industrial-grade panel computer equipped with RS232 interfaces enables effective management and central control of warehouse equipment, which increases the efficiency of operations. The solid housing design is designed to operate in demanding industrial conditions. Thanks to its resistance to dust and pollution, the device guarantees stable and reliable operation even in environments with a high level of dirt.



up...

menu...

## ACCESSOIRES AND AVAILABLE VERSIONS

The BiBox 156-I58 industrial panel computer is available in various variants that can be adapted to individual user requirements. The number of the selected hardware configuration is directed to a detailed description of the technical parameters contained in the table below. Additionally, there is an option to prepare a non-standard configuration not included in the current offer, at the customer's special request.



More pictures of the device available in the ["Gallery"](#) tab.

	v.1	v.2	v.3	v.4	v.5	v.6	v.7	v.8
Bluetooth	—	+	+	+	+	—	+	+
WiFi (standard)	—	+	+	+	+	—	+	+
Windows 11 Pro	—	+	—	—	+	+	+	+

1000nits

- - - + - + - +

WiFi 6

- - - - - + - -

4G

- - - - - + - -