



BiBox 215-I58 v.6 - Professional 21.5-inch 1080p panel PC, 1000 nits industrial display, Intel i5, 8GB RAM, 256GB SSD, RS232, LAN, Windows 11 Pro, WiFi 6, and LTE - For transport automation and logistics



Category:	Industrial Panel PC Computers
Manufacturer:	Mobikator
Supported OS:	Windows
Installed OS:	Windows 11 Pro
Screen size:	21.5 inch
Resolution:	1920x1080
Aspect ratio:	16:9
Brightness:	1000 nits
Touchscreen:	Capacitive
CPU Support:	Intel Core i3, i5, i7 - 8 generation
Installed CPU:	Intel core i5-8250U Fanless
Graphic Card:	CPU Integrated graphics HD Graphics support 1080p HD photo quality
Storage (HDD) Support:	SSD
Installed Storage (HDD):	256GB
Memory Support:	DDR4
Installed Memory:	8GB
IP Norm:	IP65

IP Level (front panel):	IP65
IP Level (back panel):	-----
Temp:	-10 °C to 60 °C
Storage Temp:	-20 °C to 70 °C
Humidity:	5% - 95% Non-Condensing
Anti-shock:	----
Anti-vibration:	5-500Hz,0.026G ² /Hz,2.16Grms,X,Y,Z1 hour per axis
Barcode reader:	No
RFID scanner (reader):	No
Others:	---
LAN:	2 ports RJ-45
Wireless LAN card:	WiFi 6
3G:	Yes
4G LTE:	Yes
Bluetooth:	Yes
GPS:	No (optional)
Ports - rear panel:	USBx4 HDMIx1 LANx2 RS232x2 MIC EARx1 Power DC12V
Ports - front panel:	-----
Ports - left panel:	-----
Ports - right panel:	-----
Expansion:	---
Power:	Ext.Power Supply AC100-240VWorking voltage DC12V Power consumption ≤80W
Power Consumption:	---
Watch Dog Timer:	Yes
Mounting VESA:	100 x 100 mm
Folding Bracket (for office type working):	No (optional)
Chipset:	---
CD/DVD Drive:	No

Audio:	Realtek ALC662 High Definition Audio (HD)Line in Line out
TV Tuner:	No
Backlight MTBF:	---
Contrast Ratio:	1000:1
Dual display:	---
Viewing Angle:	89°/89°/89°/89°(R/L/U/D)
Touch Life(contacts):	50 000
Surface hardness (display):	7H
Color Resolution:	16.7 million
Response time touch-panel (ms):	15 ms
Housing material:	Metal
Dimensions:	525.8x317.3x52mm
Fanless:	Yes
Weight:	6kg

4 123,58 zł

net price: 3 352,50 zł

BiBox 215-I58



CERTIFICATES

SPECIFICATION

RESISTANCE

WIRELESS COMMUNICATION

APPLICATION

ACCESSORIES AND AVAILABLE VERSIONS

The BiBox 215-I58 Industrial Panel PC is a durable and versatile solution that combines the performance of a desktop computer with the convenience of a touchscreen interface. Featuring a 21.5-inch Full HD (1920×1080 px) display and an energy-efficient Intel Core i5-8250U processor, it delivers high computing power with low energy consumption. The IP65-rated front panel protects against dust, splashes, and vibrations, making it ideal for use in

production halls, assembly lines, and control systems. The touch-screen computer BiBox 215-I58 ensures stable and reliable performance even in harsh industrial environments.

CERTIFICATES



The BiBox 215-I58 panel PC holds key CE, FCC, and RoHS certifications, confirming compliance with international safety and quality standards. The CE mark ensures conformity with EU directives, FCC guarantees electromagnetic compatibility, and RoHS confirms the absence of hazardous materials. This comprehensive certification proves that the device meets the highest technical, environmental, and operational standards.

[up...](#)

SPECIFICATION

BiBox 215-I58	
Certifications	CE FCC RoHS
Network	1× Realtek RTL 8111E Gigabit Ethernet controller
Processor	Intel Core i5-8250U Fanless
Graphics	Integrated
Operating system	Windows 11 Pro
Memory	8GB RAM 16GB * (optional)
SSD	256GB 128GB * (optional) 512GB * (optional)
Display	21.5" (1920x1080) 1000 nits 250 nits * (optional)
Touch screen	Capacitive (10-point)
Viewangle	89°/89°/89°/89° (R/L/U/D)
Protection	IP65 (front panel)
Communication	BT WiFi 6 4G

BiBox 215-I58

Connectors	1x MIC 4x USB 2x LAN 1x EAR 1x HDMI Power DC12V 2x RS232
	RS485 instead of 1x RS232 * (optional)
	RS422 instead of 1x RS232 * (optional)
	4 additional RS232 ports * (optional)
	9-36V power supply * (optional)



Detailed device specification is available in the "Technical data".

The BiBox 215-I58 is an advanced, industrial panel PC driven by the energy-efficient Intel Core i5-8250U processor, designed for demanding industrial environments. Its four cores and eight threads deliver excellent multitasking performance, while the large cache memory ensures fast data access and smooth operation of complex applications.

up...

Dimensions

The durable BiBox 215-I58 industrial panel PC measures 525.8 × 317.3 × 52 mm and features a slim, space-saving design perfectly suited for control cabinets and limited industrial environments.

Dimensions	525.8 × 317.3 × 52 mm
-------------------	-----------------------

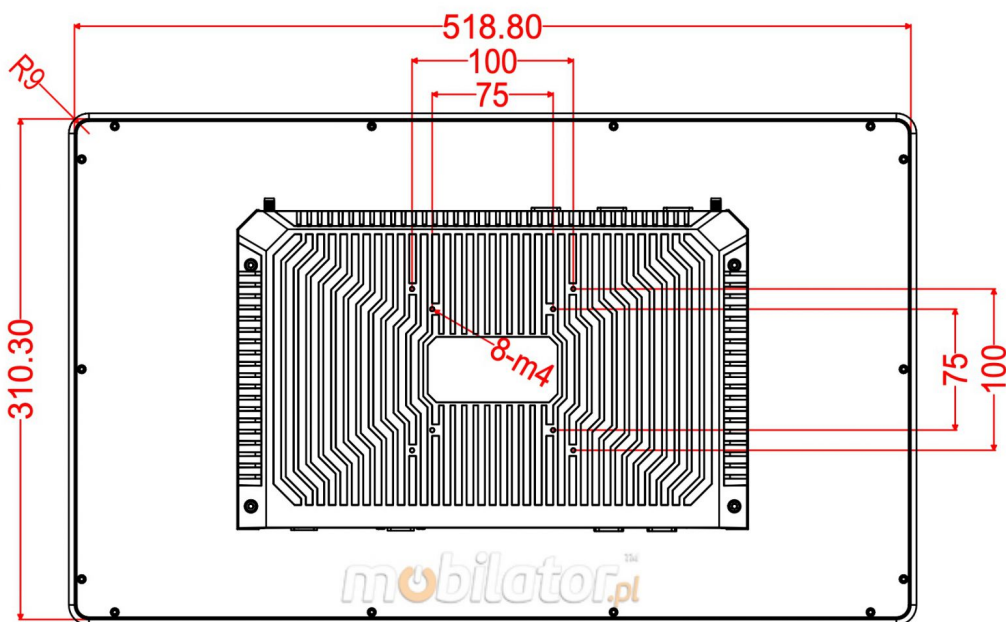
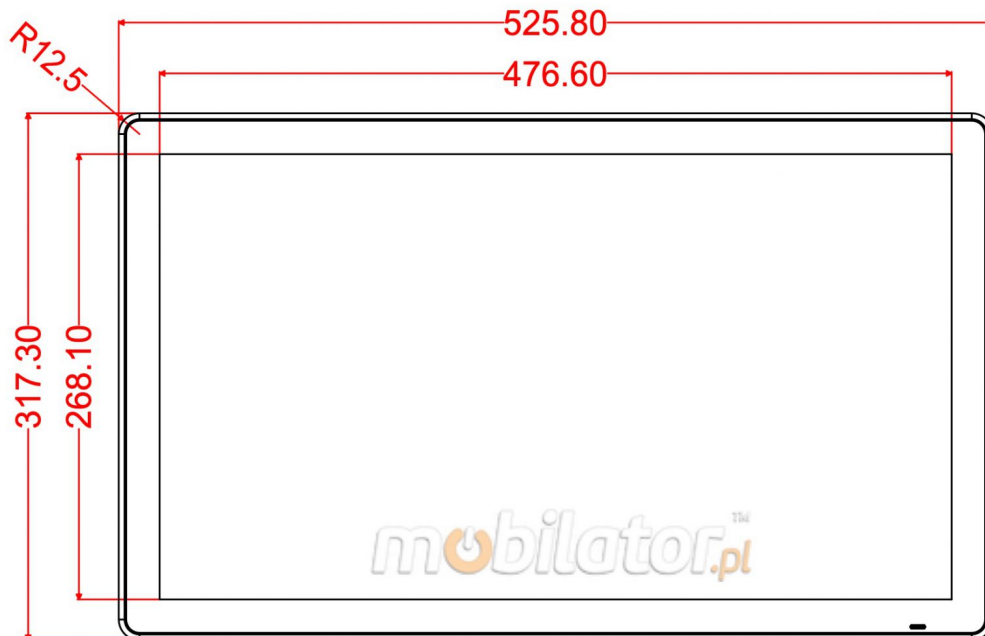

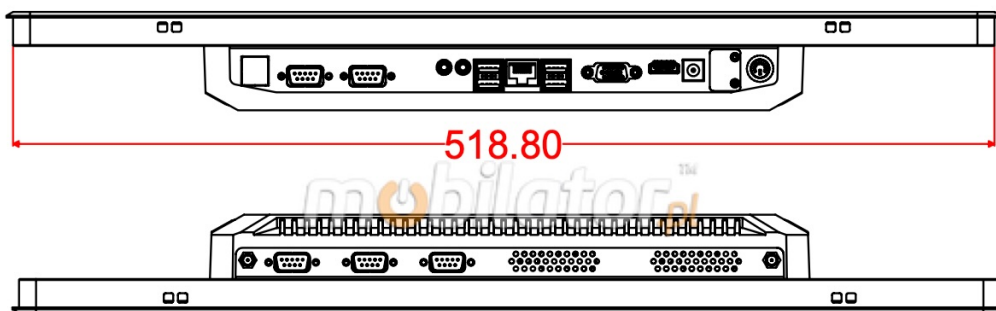
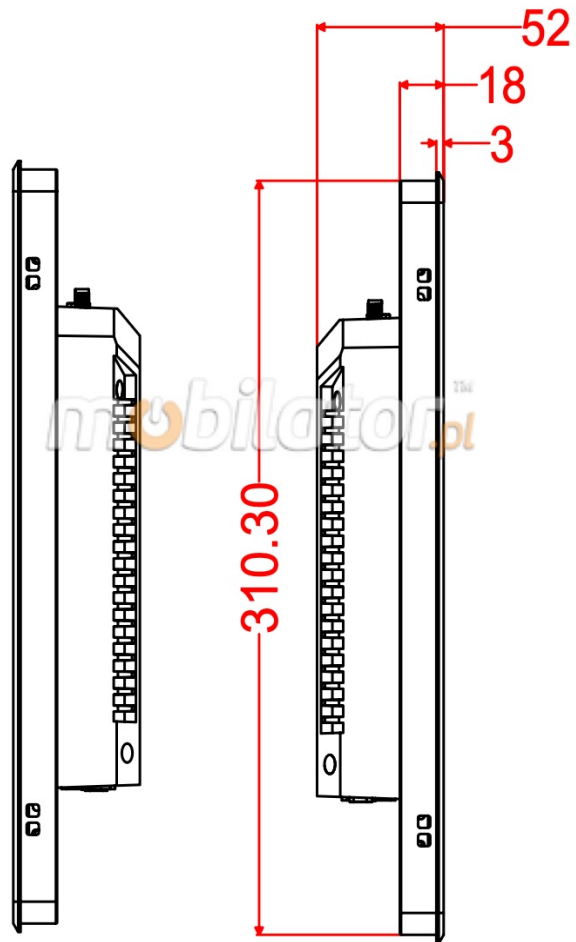

up...

Capacitive screen



A capacitive screen detects touch by changing the electrostatic field created when you touch the screen with your finger. Unlike resistive technology, it doesn't require any physical pressure. This makes operation precise and fluid, with the screen responding to even the lightest touches. This technology also supports multitouch, allowing for simultaneous recognition of multiple touch points, enabling gestures such as zooming or rotating.

Aluminium Bezel Style
*(option)



ALUMINIUM BEZEL STYLE

Aluminum Bezel Style is a solution in which the screen frame is made of aluminum or finished with this material. This gives the device an immediate, premium look and significantly increases the feeling of solidity. Aluminum, being a more durable and rigid material than plastic, provides better protection against scratches and damage. Furthermore, in addition to its aesthetic appeal, this metal dissipates heat more effectively while maintaining the device's slim profile without compromising structural strength.

***At the customer's request, it is possible to order the BiBox 215-I58 device in the Aluminum Bezel Style version. Version available in the configurator.**

1000-nits screen



The BiBox 215-I58 is a solid, rugged and reliable industrial panel PC designed for efficient operation in demanding indoor and outdoor environments. Its 1000-nit brightness display ensures excellent visibility in shaded areas or under moderate sunlight. This optimized luminance allows for comfortable operation and clear data monitoring, regardless of lighting conditions.



up...





RESISTANCE

IP65

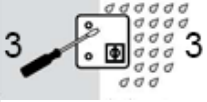

The IP65-rated front panel provides complete protection against dust and resistance to powerful water jets from any direction. This makes it an excellent, reliable, and durable solution for demanding operating conditions where the device is exposed to atmospheric conditions but not to complete immersion in water

First digit	Protection level	Second digit
No special protection	0  0	No special protection
Protection from solid objects greater than 50mm in diameter	1  1	Protection from dripping water
Protection from object not greater than 12mm in diameter	2  2	Protection from vertically dripping water (tilted up to 15°)
Protection from object not greater than 2,5mm in diameter	3  3	Protection from sprayed water (tilted up to 60°)

Firts digit	Protection level	Second digit
Protection from object not greater than 1mm in diameter	 4 4	Protection from splashed water
Complete protection against contact, Protection against dust deposit	 5 5	Protection from water projected from a nozzle
Complete protectionm against contact, protection from infiltration of dust	 6 6	Protection against heavy seas, or powerful jets of water
	 7	Protection against immersion
	 8	Protection against complete, continuous submersion in water

Extreme temperatures

The BiBox 215-I58 is engineered for operation in the harshest conditions. Its rugged, reinforced design ensures reliable performance in a wide temperature range from -10°C to 60°C and in high-humidity environments of up to 95% relative humidity (non-condensing). This thermal resilience also extends to storage, safe from -20°C to 70°C, providing maximum flexibility in logistics and warehousing.

Working Temp.	-10°C do 60°C
Storage Temp.	-20°C do 70°C
Humidity	5% do 95%

up...

COMMUNICATIONS AND CONNECTIONS

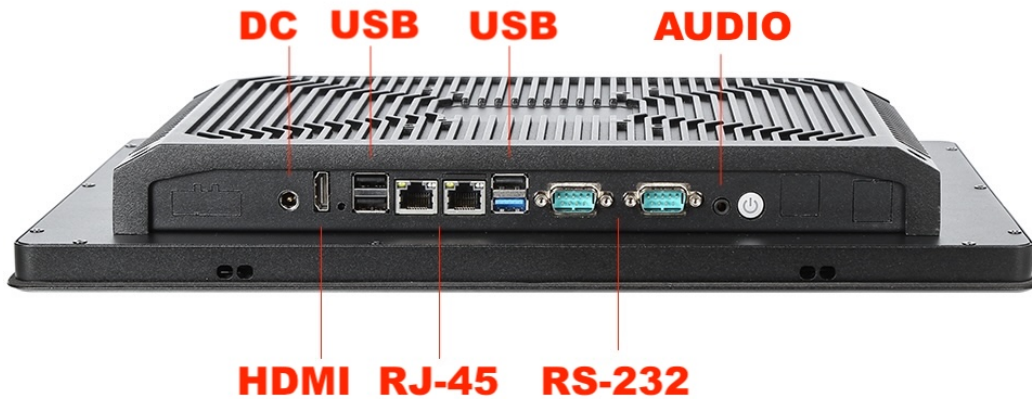

Communication

The device features two versatile Mini-PCIe expansion slots, allowing the installation of additional modules. You can add a WiFi card for wireless internet, a 3G/4G module for mobile connectivity, or an mSATA drive to expand storage. This capability makes the panel highly flexible and easily customizable for a wide range of industrial applications.

Ports

The PC panel BiBox 215-I58 provides a comprehensive set of connectors for maximum functionality in industrial environments. Connectivity includes four USB ports, an HDMI video output, and dual LAN ports for stable network communication. Two RS-232 (one port can be replaced with either RS485 or RS422) serial ports are essential for system integration, while full audio support includes a microphone input (MICx1) and headphone output (EARx1). Powered by DC 12V, the panel's modern design eliminates the outdated VGA

port, highlighting its contemporary industrial appeal. On client's wish, four additional RS-232 ports can be added.

APPLICATION

Trade and Services

The BiBox 215-I58 Panel PC is an exceptionally versatile tool that performs well in both intensive industrial environments and the retail sector. Designed for centralized system control, the efficient display of detailed information (e.g., about products or production line status), and the dynamic presentation of content, including advertising, the device's true strength lies in its installation flexibility: thanks to full VESA compatibility, the panel can be quickly and securely mounted in almost any location. Regardless of the application—whether it's a cash register terminal, a process monitoring point on the factory floor, or a fleet management component for delivery vehicles—the BiBox 215-I58 guarantees reliability, perfectly suited to any demanding operational network.



Industry and Construction

Specialized panel computers are synonymous with reliability in the harshest operating environments. Their reinforced enclosures, certified to the IP65 (front panel) standard, provide complete resistance to dust and powerful water jets. This makes devices like the BiBox 215-I58 the ideal choice for applications where traditional equipment would quickly deteriorate – from demanding construction sites, to dynamic logistics centers, to intensive production lines. This durability allows you to rely on your equipment without fear of damage.

Warehouse

This reliable panel computer was created to accelerate warehouse operations. Equipped with RS-232 interfaces, it enables centralized device control, making management simple and efficient. Furthermore, its durable construction is fully resistant to industrial factors such as dust and dirt. This ensures stable and reliable operation even in the harshest and most polluted production environments.



up...

ACCESSORIES AND AVAILABLE VERSIONS

The BiBox 215-I58 heavy-duty panel PC is available in several versions tailored to different needs. Clicking on the hardware configuration number will redirect you to the product with the parameters listed in the table below. Furthermore, upon request, we can create a configuration not currently available.

	v.1	v.2	v.3	v.4	v.5	v.6	v.7	v.8
BT + WiFi	—	+	+	+	+	+	+	+
Windows 11 Pro	—	+	—	—	+	+	+	+
4G + WiFi 6	—	—	—	—	—	+	—	—
1000 nit	—	—	—	+	—	+	—	+
8GB RAM + 128GB SSD	+	+	—	—	—	—	—	—
8GB RAM + 256GB SSD	—	—	+	+	+	+	—	—

16GB RAM +

512GB SSD



More photos in full resolution available in the "Gallery".