

Windows 11 intel



EMDOOR X14A (i5) v.2 - Industrial laptop with NFC, GPS, 32GB RAM, 512 GB SSD drive, sunlight-readable screen (1000 nits)

Category:	Laptops - Rugged
Manufacturer:	EMDOOR
Operating System:	Windows
Display:	14" IPS 1920x1080
Brightness:	1000 nits
Touch screen:	No
Processor:	Intel Core i5-1235U
Graphics card:	Intel Iris Xe
Memory:	32GB DDR5
Hard Drive:	512GB SSD
Durability:	IP65 MIL-STD 810H
Security:	IP65 MIL-STD 810H
Sand and dust:	IP6X
Waterproof:	IPX5
Drop:	up to 1.5m
Shock:	MIL-STD 810H
Vibration:	MIL-STD 810H
Temperature:	Work temp.: -20°C do 60°C Storage temp.: -30°C do 70°C

Humidity:	0 - 95%
1D barcode scanner (reader):	No
2D barcode scanner (reader):	No
RFID scanner (reader):	No
Other:	NFC
Battery:	4850mAh
Working time on battery:	6.5 hours
Fast battery replacement ability:	Yes
HotSwap battery:	No
LAN:	Yes
WLAN:	WiFi 6
WAN:	-----
Bluetooth:	Bluetooth 5.1
GPS:	Yes
In/Out:	USB3.2 Gen2 x1, USB3.2 Gen1 x1, USB2.0 x1, Thunderbolt 4 (type C) x1, Micro SD x1, SIM x1. 3.5mm Audio Jack x1, 5.5mm DC-In jack x1, HDMI 2.0a mini x1, RJ45 x2, RS232 x1
Flash Card Reader:	Micro SD
Audio:	Microphone, speaker 3W
CD/DVD:	No
COM port:	Tak
Camera:	Front: 5Mpx
Magnetic card reader (MSR):	No
Microchip card reader:	No
Keyboard:	Yes - connected to device
Additional Navigation Devices :	No
Optional accessories:	Adapter, additional battery, quadruple battery charging station
Docking station connector:	No

VESA standard – holders and mounts support:	No
BIOS:	-----
Chipset:	-----
Swivel Hinge:	-----
Contrast:	-----
VGA out:	No
TV Out:	No
TV Tuner:	No
Casing material:	-----
Color:	Black
Size:	363.2×287.4×42.1mm, 2.97kg
Fanless casing:	Yes

1 707,18 €

net price: 1 387,95 €



SPECIFICATION

RESISTANCE

WIRELESS COMMUNICATION

APPLICATION

ACCESSORIES AND AVAILABLE VERSIONS

The rugged industrial laptop Emdoor X14A is built for demanding environments. It features a 14-inch display with 1920×1080 px resolution and 1000-nit brightness, ensuring excellent visibility even in bright sunlight. Powered by an Intel Core i5-1235U processor with 32 GB RAM and 512 GB SSD storage, it is housed in an IP65-rated

durable case. Connectivity options include NFC, Wi-Fi 6, Bluetooth, and GPS, while the 4850 mAh battery provides up to 6.5 hours of field operation.

SPECIFICATION

Emdoor X14A	
Processor	Intel Core i5-1235U
Graphics	Intel Iris Xe
Operating system	Windows 11 Pro * (optional) Windows 11 IoT * (optional)
RAM	32GB 16GB * (optional)
SSD	512GB 256GB * (optional) 1TB * (optional)
Display	14" IPS, 1920×1080, 1000 nits
Battery	4850mAh (removable)
Camera	5MP front
Protection	IP65
Communication	Wi-Fi 6 Bluetooth 5.1 GPS NFC * (option: none)

Emdoor X14A	
Connectors	USB 3.2 Gen1 x1 USB 3.2 Gen2 x1 USB2.0 x1 USB-C x1 Micro SD x1 SIM card x1 3.5mm Audio Jack x1 5.5mm DC-In jack x1 HDMI 2.0a mini x1 RJ45 Ne
SIM card	SIM

* Optional equipment, available on specific versions only.



Detailed device specification is available in the "Technical data".

The Emdoor X14A industrial laptop is powered by the energy-efficient Intel Core i5-1235U processor, delivering high performance. The chip features ten cooperating cores, enabling smoother multitasking and faster data processing. Its multi-level shared cache is dynamically allocated to each core depending on the workload, reducing average memory access time and improving overall efficiency.

Ergonomic design



The rugged Emdoor X14A tablet is designed for challenging environments – from production halls to open construction sites. Its IP65-certified housing protects components from dust and water, while reinforced seals absorb shocks and withstand drops from up to 1.5 meters. Non-slip edges and strengthened corners ensure a secure grip, making this tablet a reliable tool for demanding fieldwork.

Dimensions	363.2×287.4×42.1mm
Net weight	2.97kg

Connectors and buttons

The versatile Emdoor X14A industrial laptop comes with a well-designed set of interfaces, allowing seamless connection of various accessories and peripherals. Available ports include USB-C, USB 3.2, HDMI, a 3.5 mm audio jack, as well as a SIM card slot and an RJ-45 connector, making this notebook an excellent tool for both office and field operations.





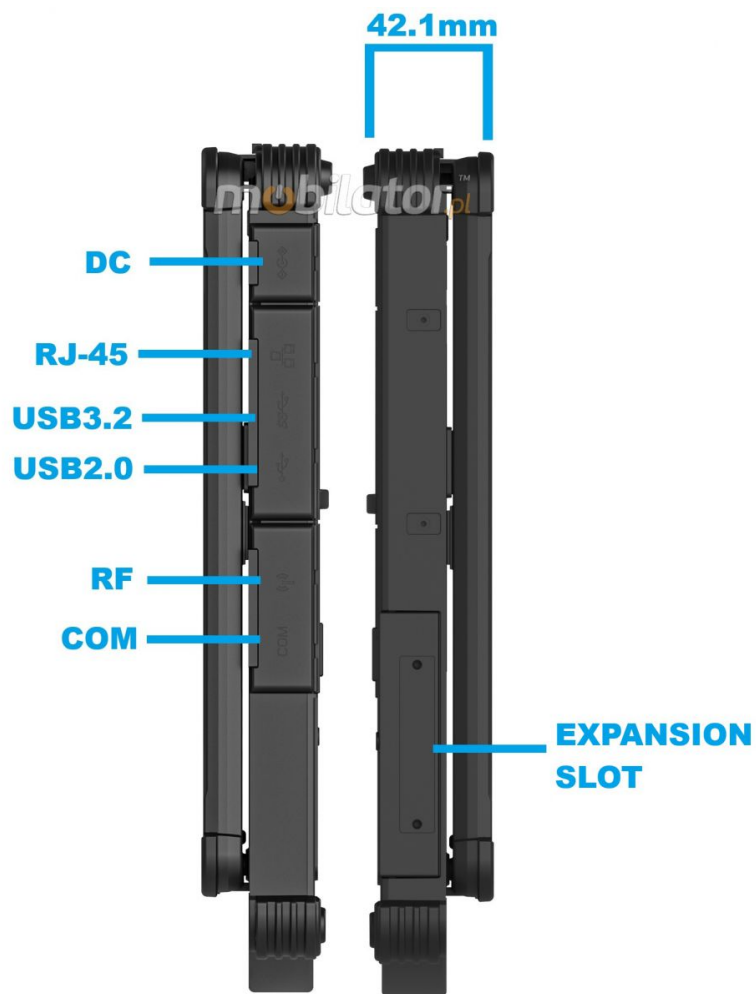









RESISTANCE

IP65 protection class



The rugged Emdoor X14A laptop is built for demanding environments. Its IP65-certified design ensures complete protection against dust and resistance to temporary water immersion. This reliable industrial notebook is the perfect solution for industries where durability and resistance to harsh conditions are crucial.

First digit	Protection level	Second digit
No special protection	0  0	No special protection
Protection from solid objects greater than 50mm in diameter	1  1	Protection from dripping water
Protection from object not greater than 12mm in diameter	2  2	Protection from vertically dripping water (tilted up to 15°)
Protection from object not greater than 2,5mm in diameter	3  3	Protection from sprayed water (tilted up to 60°)

First digit	Protection level	Second digit
Protection from object not greater than 1mm in diameter		Protection from splashed water
Complete protection against contact, Protection against dust deposit		Protection from water projected from a nozzle
Complete protection against contact, protection from infiltration of dust		Protection against heavy seas, or powerful jets of water
		Protection against immersion
		Protection against complete, continuous submersion in water

MIL-STD 810 Standard



The durable and rugged Emdoor X14A laptop meets the MIL-STD-810H standard, used by the U.S. Army, ensuring resistance to harsh environmental conditions. With mechanical durability proven by tests (1.5 m drop resistance), this laptop is perfectly suited for demanding industrial and field operations, providing reliability even in extreme scenarios.

Extreme temperatures

The rugged Emdoor X14A field laptop is designed for demanding conditions and operates reliably in temperatures ranging from -20°C to 60°C. When stored while powered off, it withstands -30°C to 70°C, ensuring durability and stability even in extreme environments.

Working Temp.	-20°C to 60°C
Storage Temp.	-30°C to 70°C
Humidity	0% to 95%

WIRELESS COMMUNICATION

GPS Navigation

The waterproof and durable Emdoor X14A laptop is equipped with a precise GPS module that combines low power consumption with high positioning accuracy. This rugged field laptop enables fast and stable location tracking, ensuring safe navigation in challenging industrial and outdoor conditions while significantly improving work efficiency in the field.

Bluetooth 5.1

The modern and functional Emdoor X14A laptop is equipped with

Bluetooth 5.1, enabling energy-efficient short-range communication with devices such as printers, keyboards, RFID readers, scanners, and headsets. This powerful mobile laptop delivers higher connection stability and speed compared to previous versions while reducing power consumption, enhancing both comfort and efficiency in field operations.

Wireless Wi-Fi

The professional Emdoor X14A laptop supports dual-band Wi-Fi 802.11 a/b/g/n/ac, operating in the 2.4 GHz and 5.8 GHz ranges. This ensures fast and stable access to local networks and the Internet both in the office and in the field, with data transmission speeds reaching up to 9.6 Gbps theoretically.

Standards	WiFi 6 802.11(a/b/g/n/ac)
Frequencies	2.4GHz/5.8GHz (Dual-Band)

NFC communication

(optional)

NFC (Near Field Communication) technology is a short-range wireless communication standard that allows data exchange over just a few

centimeters. NFC is ideal for applications such as access control, employee authentication, logistics, and payment processing. The modern industrial Mobipad tablet enables tag reading and integration with smart card systems.

APPLICATION

Trade and Services

The rugged and functional Emdoor X14A laptop is an ideal tool for sales and field representatives. With modern business applications, it enables fast data collection, client verification, offer presentation, and the creation of sales documents. This mobile warehouse laptop allows issuing invoices, creating orders, and synchronizing data with the ERP system in real time, regardless of location, thanks to GSM or Wi-Fi connectivity.



Industry and Construction

The rugged and waterproof Emdoor X14A laptop features dust and water resistance (IP65 certification), enabling safe use in industrial halls, construction sites, and challenging environments. With modern business applications, this practical field laptop is ideal for work supervision, data collection, and managing infrastructure and human resources.



The powerful and rugged Emdoor X14A industrial laptop is ideal for automotive service centers and workshops. Its durable design, along with Wi-Fi, and GPS connectivity, assists technicians in rapid vehicle diagnostics, analysis of onboard system data, and handling service documentation. Installing specialized software allows for error reading, vehicle system configuration, and access to diagrams and repair history, significantly improving work efficiency and accuracy.



ACCESSORIES AND AVAILABLE VERSIONS

We offer a range of additional accessories for this innovative tablet to further enhance its functionality and comfort of use. Below is a list of available accessories. Click on the accessory name or the "Check" link to be taken to a page with a description and price of the accessory.

Quadruple charging station



Station that allows charging up to 4 batteries at once.

[Check](#)

Adapter



Allows to charge your device.

Check

Additional battery



Additional battery for the device.

Check

The rugged Emdoor X14A laptops are available in several versions, tailored to meet different user needs. Clicking on a configuration number directs to a detailed product visualization with specifications listed in the table. Upon request, a custom configuration not currently available in the standard offer can also be created.

	v.1	v.2	v.3	v.4	v.5	v.6
16GB+256GB	+	—	—	—	—	—
32GB+512GB	—	+	+	+	—	—
32GB+1TB	—	—	—	—	+	+
Windows 11 Pro	—	—	+	—	+	—
Windows 11 IoT	—	—	—	+	—	+
NFC	—	+	—	—	+	+



More photos in full resolution available in the "Gallery".