

IBOX-700 (i5-7200U) Barebone

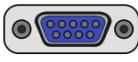

**BAREBONE**



IBOX-700 (7200U) Barebone - Industrial fanless mini computer

<b>Category:</b>	MiniPC Industry
<b>Manufacturer:</b>	Mobilator
<b>Supported OS:</b>	Windows: 7/8//10   Linux
<b>Installed OS:</b>	-----
<b>Chipset:</b>	Intel Chipset
<b>CPU Support:</b>	Intel Core i5 7200U
<b>Installed CPU:</b>	Intel Core i5 7200U Dual Core, 2.5GHz, Turbo boost 3.1GHz
<b>Graphic Card:</b>	Intel HD Graphics 620
<b>Memory Support:</b>	SODIMM DDR4 (Max: 16GB)
<b>Installed Memory:</b>	<b>None</b> (Available in a different version)
<b>Storage (HDD) Support:</b>	SSD
<b>Installed Storage (HDD):</b>	<b>None</b> (Available in a different version)
<b>IP Norm:</b>	-----
<b>Temp:</b>	-10°C — 50°C
<b>Storage temperature:</b>	-10°C — 50°C
<b>Humidity:</b>	0% 95% Non-Condensing
<b>Others:</b>	Color Gray-Blue

<b>LAN:</b>	2xIntel i211-AT 10/100/1000M Lan
<b>Wireless LAN card:</b>	(Option)
<b>3G:</b>	(option)
<b>4G LTE:</b>	(option)
<b>Bluetooth:</b>	-----
<b>Rear Panel (ports):</b>	-----
<b>Front Panel (ports):</b>	Power ON4xCOM2xUSB2.02xUSB3VGA2xLAN
<b>Expansion:</b>	-----
<b>Power:</b>	DC 9 36V
<b>Watch Dog Timer:</b>	-----
<b>CD/DVD Drive:</b>	-----
<b>TV Tuner:</b>	-----
<b>Dimensions:</b>	185mm x 160mm x 74mm
<b>Fanless:</b>	Yes
<b>Weight:</b>	2.2 kg

**2 380,05 zł**

net price: 1 935,00 zł

# IBOX-700 (i5-7200U) Barebone



**BAREBONE**

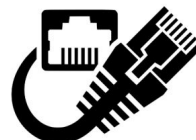
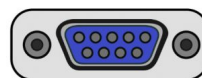

## TECHNICAL SPECIFICATION

## RESISTANCE AND DURABILITY

## CONNECTIVITY AND COMMUNICATION

## DEVICE APPLICATION

## AVAILABLE VERSIONS

Small dimensions industrial computers excel in environments where dust, dirt and moisture predominate. They are ideal for applications requiring quiet operation. Small and reliable MiniPC use heat-pipe technology and aluminum fins for passive cooling. The robust mini Industrial Computer IBOX-700 is a device designed for all industrial and non-continuous applications requiring continuous operation - 24 hours, 7 days a week.

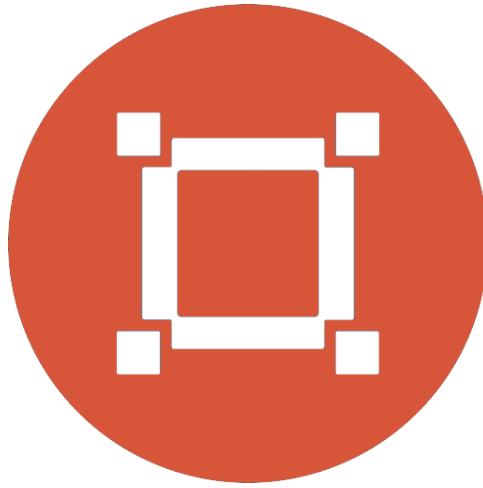

#### Small dimensions

The compact housing means that the Mini PC will fit wherever you need it and is easy to carry.



#### Lightweight design

The computer's weight does not exceed 3.0 kg, so it can be conveniently carried in a bag or backpack.



### Efficient components

The Intel  
Celeron 3865U  
dual-core CPU provides  
improved device  
performance.



### Wireless network \*

The mini PC can be  
connected to nearby  
wireless networks by  
equipping it with an  
optional Wi-Fi module.



### Quick start

\*

A modern SSD drive will increase the speed of application programs and ensure quiet computer operation.



### Passive cooling

The use of passive cooling in the Mini PC ensures silent operation and slows dust deposition.

\* Optional equipment, available only in other versions of the device.

## SPECIFICATION

## Mini-PC IBOX-700

Processor	Intel Core i5 7200U Dual Core   2.5GHz   Turbo boost 3.1GHz
Operation system	Support: Windows 7/8/10 Linux
RAM	Brak (4   8   16 GB SODIMM DDR4) *
Drive	None (SSD: 64GB   128GB   256GB   512GB) *
Graphic card	Intel HD Graphics 620
Connectivity	WiFi * 3G * 4G * LAN: 2 x Intel i211-AT 10/100/1000M
Front panel	2xUSB 3.0   2xUSB 2.0    1xVGA   Audio 1x 3P Power Phoenix Port   4x COM RS232 2xRJ45 1000M LAN    1x DC 9 36V
Rear panel	-
Available colors	Gray-Blue (other color can be customized)
Dimensions	185 x 160 x 74 mm
Weight	2.2 kg

\* Optional equipment, available only in other versions of the device.



Detailed device specification is available in the "Technical data".



### Efficient processor

The industrial mini-computer IBOX-700 uses an efficient and energy-saving Intel Celeron 3865U processor. Inside it there are two cooperating cores enabling more efficient processing of many tasks at the same time. The shared cache memory in which the multilevel hierarchy is used is dynamically allocated to each processor core depending on the load. This reduces the average access time to the main memory. It offers improved manageability by limiting downtime and maintaining productivity by isolating computing activities into separate partitions.

### Interfaces



## Dimensions

Thanks to the small dimensions of the MiniPC, the IBOX-700 is versatile for use at home, in the office and in the industry, for example in the production hall. It's literally everywhere, and it can be mounted on the back of the monitor to optimize the job.

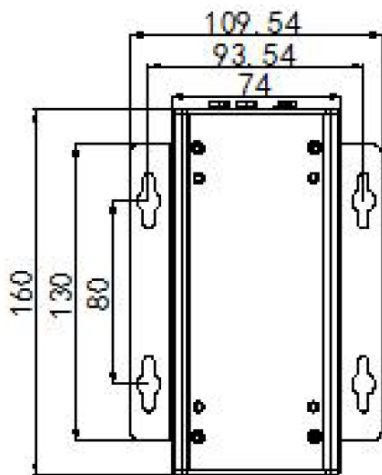
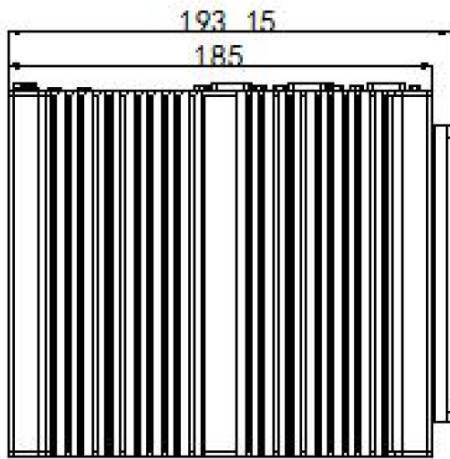

<b>Dimensions</b>	185 x 160 x 74 mm
<b>Weight</b>	2.2 kg

Passive cooling

The industrial Mini PC uses a proven cooling system, based only on solid elements, mainly heat sinks. The system uses the phenomenon of metals passing thermal energy into the environment - there are no additional moving elements in the form of eg fans. This solution ensures noiseless operation, lower failure rate and greater protection against dust and other dirt while reducing the amount of energy consumed.

## RESISTANCE AND DURABILITY



### Temperatures

#### IBOX-700

is designed for continuous operation in both very low and high temperatures ranging from  $-10^{\circ}\text{C}$  to  $50^{\circ}\text{C}$ . If the device is switched off, it can already handle temperatures in the range of  $-10^{\circ}\text{C}$  to  $50^{\circ}\text{C}$ .

<b>Work temp.</b>	$-10^{\circ}\text{C}$ do $50^{\circ}\text{C}$
<b>Storage temp.</b>	$-10^{\circ}\text{C}$ do $50^{\circ}\text{C}$

**Humidity**

0% do 95%

**Mechanical damage**

The passive cooling system used in the MiniPC IBOX-700

combined with the SSD\* disk makes this computer very resistant to various types of mechanical injuries. An additional advantage of industrial computers is a solid construction made of high quality aluminum and specially designed in such a way that in addition to high efficiency in heat dissipation, it can also resist any external damage.

## CONNECTIVITY AND COMMUNICATION

**Wireless network (Option)**

The dual-band Wi-Fi module provides quick access to the network wherever you can connect to secured or open Wi-Fi networks. This is a convenient solution for people who have a router at home or place of residence and a wireless network that can be used at no extra charge. Industrial mini-PC IBOX-700

has been equipped the standard of - 802.11n, which allows transfer of files at a dizzying speed of up to 300 Mb / s.

**Wired LAN Network**

The MiniPC IBOX-700

has built-in Realtek network adapter that can work in a fast Gigabit Ethernet network.



## DEVICE APPLICATION

Trade and service

Mini PC is an ideal tool to support us in the implementation of many activities in the field of trade, small dimensions increase the possibility of its adaptation to activities such as issuing invoices or preparing documentation, which in turn allows us to convenient and optimal sales management. The VESA holder mounted to the housing provides many installation options, eg in stores (at the cash register, under the desktop), in factory halls or in a delivery truck.

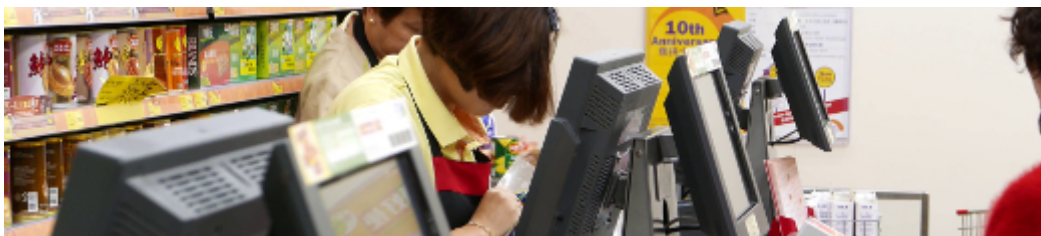

Warehouse and logistics

Thanks high performance an industrial computer can be used to connect multiple devices in a warehouse and make their management much easier. Its

rugged casing and the fanless cooling system are ideal for harsh environments in such rooms. The solid construction guarantees long-lasting work, even in environments with high dustiness and dirt.



## Transport and motorization

A small industrial computer can be used in transport thanks to the ability to work on 12V power supply. Then the mini computer can be used in passenger cars, buses, trams, taxis, trains and even in airplanes. It allows you to inform the driver about the current state of the vehicle, transfer its current location to the management center, display information for passengers, etc. It performs well in vehicles where small dimensions are important.



More photos in full resolution available in the "Gallery".

## AVAILABLE VERSIONS



Phoenix connector



Wall bracket



Power adapter



Power cord



CD drive

The industrial mini-computer IBOX-700

is offered in several versions to suit different needs. By clicking on the number of the hardware configuration you will be redirected to the product with the parameters given in the table below. In addition, it is possible to create a configuration that is currently unavailable on the customer's request.

	v.1	v.2	v.3	v.4	v.5	Barebone
WiFi	+	+	+	-	-	-
3G	-	-	-	+	-	-
4G LTE	-	-	-	-	+	-

4GB RAM

+

-

-

+

+

-

8GB RAM

-

+

-

-

-

-

16GB RAM

-

-

+

-

-

-

64GB SSD

+

-

-

+

+

-

256GB SSD

-

+

-

-

-

-

512GB SSD

-

-

+

-

-

-