

## iBOX N112 v.2



IBOX N112 BAREBONE - Aluminum miniPC with quad-core Intel Celeron processor, 4x USB 2.0, 4x RS232 and 10-pin Phoenix ports

|                                 |                                   |
|---------------------------------|-----------------------------------|
| <b>Category:</b>                | MiniPC Industry                   |
| <b>Manufacturer:</b>            | Mobikator                         |
| <b>Supported OS:</b>            | Windows: 7/8/10   Linux   Pfsense |
| <b>Installed OS:</b>            | -----                             |
| <b>Chipset:</b>                 | Intel Chipset                     |
| <b>CPU Support:</b>             | Intel Celeron                     |
| <b>Installed CPU:</b>           | Intel Celeron J1900               |
| <b>Graphic Card:</b>            | Intel HD Graphics 688Mhz          |
| <b>Memory Support:</b>          | DDR3L (max 8GB)                   |
| <b>Installed Memory:</b>        | <b>4 GB</b>                       |
| <b>Storage (HDD) Support:</b>   | SSD (SATA, M.2), HDD              |
| <b>Installed Storage (HDD):</b> | 64 GB SSD                         |
| <b>IP Norm:</b>                 | -----                             |
| <b>Temp:</b>                    | -20°C — 60°C                      |
| <b>Storage temperature:</b>     | -10°C — 70°C                      |
| <b>Humidity:</b>                | 0% ~ 95%                          |
| <b>Others:</b>                  | Color Silver Blue                 |
| <b>LAN:</b>                     | 1*Intel i211-AT 1000M LAN         |
| <b>Wireless LAN card:</b>       | Option                            |

|                             |  |
|-----------------------------|--|
| <b>3G:</b>                  | -----  |
| <b>4G LTE:</b>              | -----  |
| <b>Bluetooth:</b>           | option   |
| <b>Rear Panel (ports):</b>  | 1xDC12V; 1xVGA; 1xHDMI; 1xUSB3.0; 2xRS232; 2xRJ45-LAN; 1xSIM; 10xPIN Phoenix |
| <b>Front Panel (ports):</b> | 1*Włącznik 4*USB2.0;2xRS232  |
| <b>Expansion:</b>           | Power Adapter   Power cable   Vesa bracket                                   |
| <b>Power:</b>               | 12V  |
| <b>Watch Dog Timer:</b>     | yes  |
| <b>CD/DVD Drive:</b>        | -----  |
| <b>TV Tuner:</b>            | -----  |
| <b>Dimensions:</b>          | 148mm x 125mm x 58mm   |
| <b>Fanless:</b>             | Yes  |
| <b>Weight:</b>              | 1kg  |

**1 688,18 zł**

net price: 1 372,50 zł

## iBOX N112 v.2



## SPECIFICATION

## RESISTANCE AND DURABILITY

## CONNECTIVITY AND COMMUNICATION

## DEVICE APPLICATION

## AVAILABLE VERSIONS

Small dimensions industrial computers excel in environments where dust, dirt and moisture predominate. They are ideal for applications requiring quiet operation. Small and reliable MiniPC use heat-pipe technology and aluminum fins for passive cooling. The robust mini Industrial Computer IBOX N112 is a device designed for all industrial and non-continuous applications requiring continuous operation - 24 hours, 7 days a week.

Small dimensions industrial computers excel in environments where dust, dirt and moisture predominate. They are ideal for applications requiring quiet operation. Small and reliable MiniPC use heat-pipe technology and aluminum fins for passive cooling. The robust mini Industrial Computer IBOX N112 is a device designed for all industrial and non-continuous applications requiring continuous operation - 24 hours, 7 days a week.



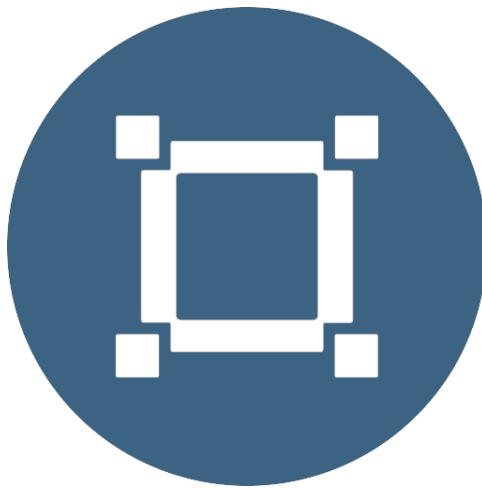

#### Small dimensions

The compact housing means that the Mini PC will fit wherever you need it and is easy to carry.



#### Lightweight design

The computer's weight does not exceed 1.0 kg, so it can be conveniently carried in a bag or backpack.



### Efficient components

The Intel Core Celeron J1900 quad-core CPU provides improved device performance.



### Wireless network

\*

The mini PC can be connected to nearby wireless networks by equipping it with an optional Wi-Fi module.



#### Quick start

A modern SSD drive will increase the speed of application programs and ensure quiet computer operation.



#### Passive cooling

The use of passive cooling in the Mini PC ensures silent operation and slows dust deposition.

\* Optional equipment, available only in other versions of the device.

## SPECIFICATION

iBOX N112 V.2

|                  |  |
|------------------|--|
| Processor        | Intel Celeron J1900 ( 4 x 2.0 Ghz )  |
| Operation system | Support: Windows 7/8/10<br>Linux and PfSense   |
| RAM              | 4GB DDR3L (8GB)<br>*   |
| Drive            | 64GB SSD   |
| Graphic card     | Intel HD Graphics (688MHz)   |
| Connectivity     | 2x Intel i211-AT 1000M LAN<br>WiFi + Bluetooth<br>*  |
| Front panel      | 4x USB 2.0   2xCOM RS232   |
| Rear panel       | 2x LAN RJ45   1x VGA   1x HDMI   1x USB 3.0   Audio<br>10 Pin Phoenix   1x SIM   2x COM RS 232   DC-in |
| Available colors | Silver+Blue  |
| Dimensions       | 148 x 125 x 58mm   |
| Weight           | 1.0 kg   |

\* Optional equipment, available only in other versions of the device.



Detailed device specification is available in the "Technical data".

### Efficient processor

The industrial mini-computer IBOX N112 uses an efficient and energy-saving Intel Celeron J1900. Inside it there are four cooperating cores enabling more efficient processing of many tasks at the same time. The shared cache memory in which the multilevel hierarchy is used is dynamically allocated to each processor core

depending on the load. This reduces the average access time to the main memory. It offers improved manageability by limiting downtime and maintaining productivity by isolating computing activities into separate partitions.

## Interfaces

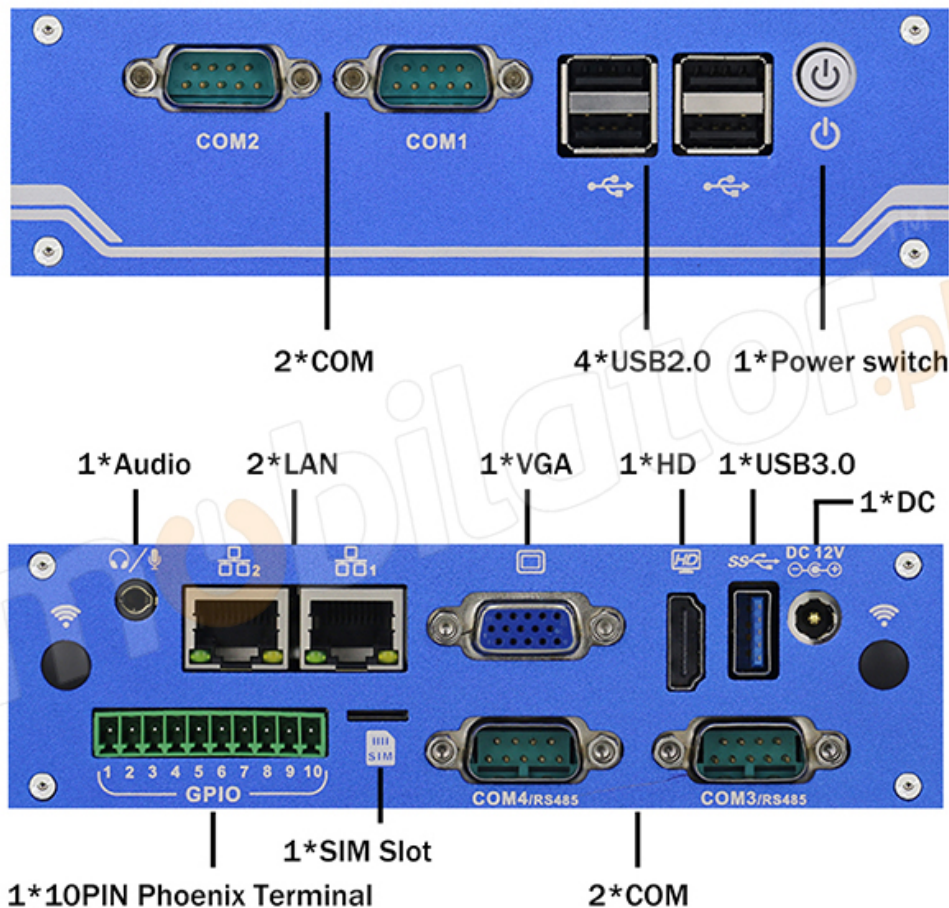

## Dimensions

Thanks to the small dimensions of the MiniPC, the IBOX N112 is versatile for use at home, in the office and in the industry, for example in the production hall. It's literally everywhere, and thanks to the VESA mount it can be mounted on the back of the monitor to optimize the job.

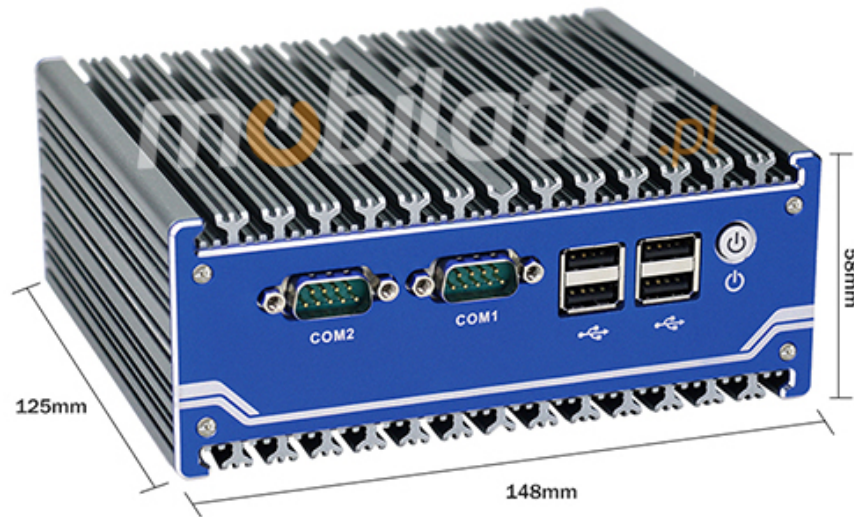

|                   |                  |
|-------------------|------------------|
| <b>Dimensions</b> | 148 x 125 x 58mm |
| <b>Weight</b>     | 1 kg             |

Passive cooling

The industrial Mini PC uses a proven cooling system, based only on solid elements, mainly heat sinks. The system uses the phenomenon of metals passing thermal energy into the environment - there are no additional moving elements in the form of eg fans. This solution ensures noiseless operation, lower failure rate and greater protection against dust and other dirt while reducing the amount of energy consumed.

## RESISTANCE AND DURABILITY

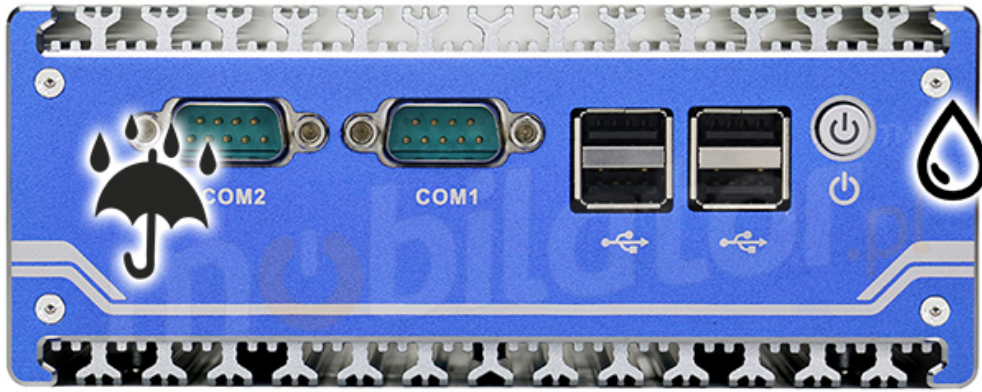

## Temperatures

IBOX

N112

is designed for continuous operation in both very low and high temperatures ranging from -20 °C to 60°C .

|                      |   |
|----------------------|---|
| <b>Work temp.</b>    | -20°C do 60°C ( with SSD)<br>0°C do 50°C (withHDD)  |
| <b>Storage temp.</b> | -10°C do 70°C (with SSD)<br>10°C do 60°C (with HDD) |
| <b>Humidity</b>      | 0% do 95%   |

## Mechanical damage

The passive cooling system used in the MiniPC IBOX N112 combined with the SSD disk makes this computer very resistant to various types of mechanical injuries. An additional advantage of industrial computers is a solid construction made of high quality aluminum and specially designed in such a way that in addition to high efficiency in heat dissipation, it can also resist any external damage.

## CONNECTIVITY AND COMMUNICATION

### Wired LAN Network

The MiniPC IBOX N112 has built-in Realtek network adapters that can work in a fast Gigabit Ethernet network.



## DEVICE APPLICATION

### Trade and service

Mini PC is an ideal tool to support us in the implementation of many activities in the field of trade, small dimensions increase the possibility of its adaptation

to activities such as issuing invoices or preparing documentation, which in turn allows us to convenient and optimal sales management. The VESA holder mounted to the housing provides many installation options, eg in stores (at the cash register, under the desktop, behind the LCD / LED monitor), in factory halls or in a delivery truck.

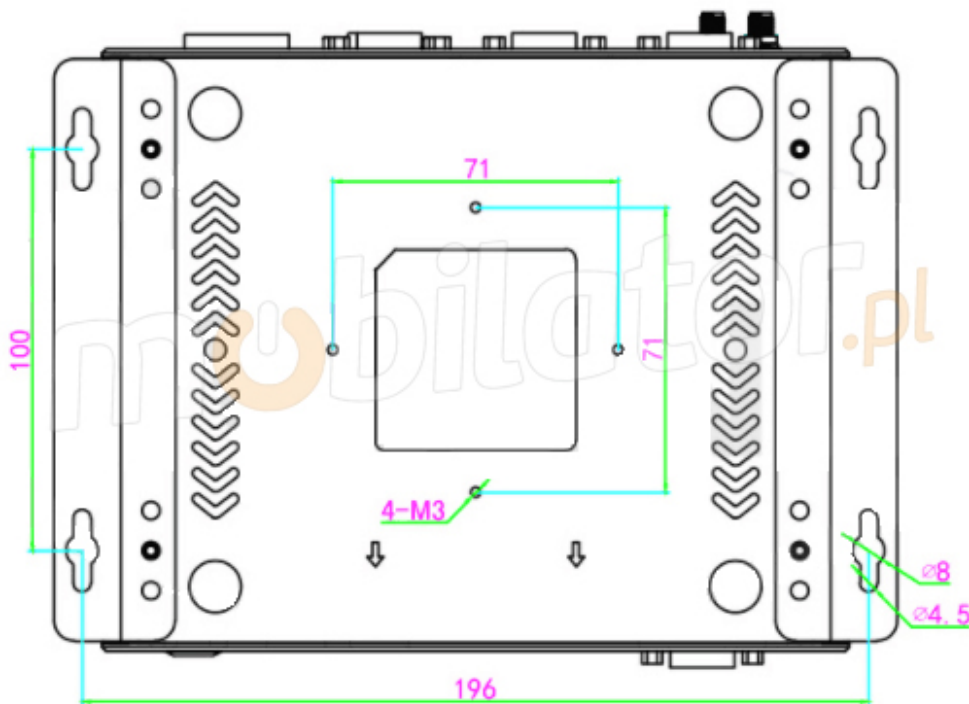
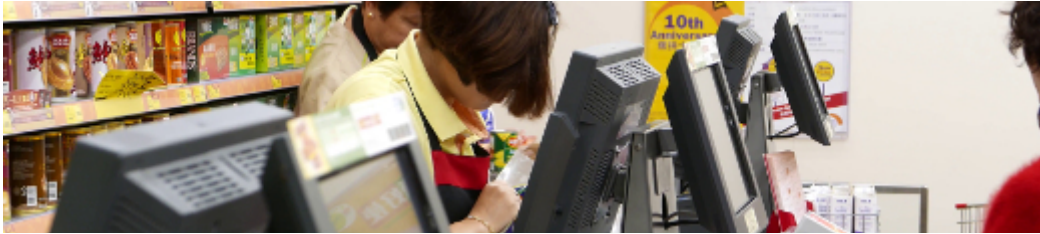

### Warehouse and logistics

Thanks high performance an industrial computer can be used to connect multiple devices in a warehouse and make their management much easier. Its rugged casing and the fanless cooling system are ideal for harsh environments in such rooms. The solid construction guarantees long-lasting work, even in environments with high dustiness and dirt.

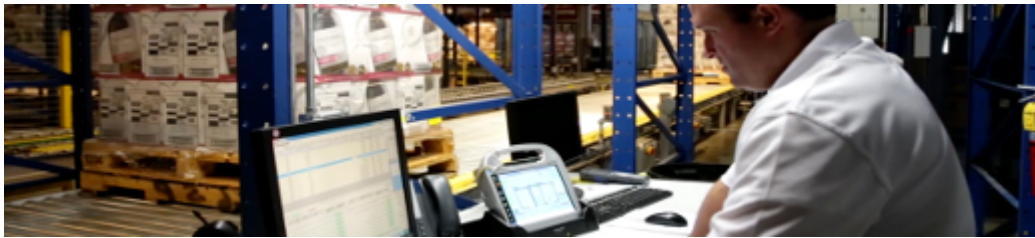

## Transport and motorization

A small industrial computer can be used in transport thanks to the ability to work on 12V power supply. Then the mini computer can be used in passenger cars, buses, trams, taxis, trains and even in airplanes. It allows you to inform the driver about the current state of the vehicle, transfer its current location to the management center, display information for passengers, etc. It performs well in vehicles where small dimensions are important.



More photos in full resolution available in the "Gallery".

## AVAILABLE VERSIONS

The industrial mini-computer IBOX N112 is offered in several versions to suit different needs. By clicking on the number of the hardware configuration you will be redirected to the product with the parameters given in the table below. In addition, it is possible to create a configuration that is currently unavailable on the customer's request.

|                 | v.1 | v.2 | v.3 | v.4  | v.5  | v.6 |
|-----------------|-----|-----|-----|------|------|-----|
| 4GB RAM DDR3L   | +   | +   | +   | +    | -    | -   |
| 8GB RAM DDR3L   | -   | -   | -   | -    | +    | +   |
| mSATA 64GB SSD  | -   | +   | -   | -    | -    | -   |
| mSATA 128GB SSD | -   | -   | +   | -    | +    | -   |
| mSATA 256GB SSD | -   | -   | -   | +    | -    | +   |
| mSATA 512GB SSD | -   | -   | -   | -    | -    | -   |
| 500GB HDD       | -   | -   | -   | -    | -    | -   |
| 1TB HDD         | -   | -   | -   | -    | -    | -   |
| 2TB HDD         | -   | -   | -   | -    | -    | -   |
| WiFi+Bluetooth  | -   | -   | +   | +    | -    | +   |
| TPM 2.0         | -   | -   | -   | -    | -    | -   |
|                 | v.7 | v.8 | v.9 | v.10 | v.11 |     |
| 4GB RAM DDR3L   | -   | -   | +   | -    | -    |     |
| 8GB RAM DDR3L   | +   | +   | -   | +    | +    |     |
| mSATA 64GB SSD  | -   | -   | -   | -    | -    |     |
| mSATA 128GB SSD | -   | -   | -   | -    | -    |     |
| mSATA 256GB SSD | -   | -   | -   | -    | -    |     |
| mSATA 512GB SSD | +   | +   | -   | -    | -    |     |
| 500GB HDD       | -   | -   | +   | -    | -    |     |
| 1TB HDD         | -   | +   | -   | +    | -    |     |
| 2TB HDD         | -   | -   | -   | -    | +    |     |

|                |   |   |   |   |   |
|----------------|---|---|---|---|---|
| WiFi+Bluetooth | - | - | - | + | - |
| TPM 2.0        | + | + | - | - | + |