

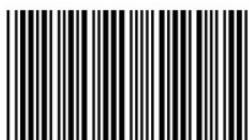

Industrial Winmate E430RM2-3BL (1D Laser)



<b>Category:</b>	UMPC - Ruggedized
<b>Manufacturer:</b>	Winmate
<b>Operating System:</b>	Android 4.1.2
<b>Display:</b>	4.3' (800x480) LED
<b>Brightness:</b>	400nit
<b>Processor:</b>	ARM®Cortex™ Dual Core - A9 1.0Ghz
<b>Memory:</b>	1GB SDRAM
<b>Hard Drive:</b>	4GB eMMC
<b>Touch screen:</b>	Touch Projective CapacitiveMulti-Touch
<b>Durability:</b>	MIL-STD 810G
<b>Drop:</b>	MIL-STD-810G Metod 516.6

<b>Shock:</b>	MIL-STD-810G Metod 516.6
<b>Vibration:</b>	MIL-STD-810G Metod 514.6
<b>Temperature:</b>	Operating temperature: -30°C - 60°C Storage temperature: -40°C - 70°C
<b>Humidity:</b>	95% non-condensation
<b>1D barcode scanner (reader):</b>	<b>1D (LASER) Motorola SE4500</b> UPC/EANCode 128Code 39Code 93Code 11Interleaved 2 of 5Discrete 2 of 5CodabarMSIChinese 2 of 5Matrix
<b>1D barcode scanner (reader):</b>	<b>1D (LASER) Motorola SE4500</b> UPC/EANCode 128Code 39Code 93Code 11Interleaved 2 of 5Discrete 2 of 5CodabarMSIChinese 2 of 5Matrix
<b>2D barcode scanner (reader):</b>	brak (dostępne w innej wersji)
<b>RFID scanner (reader):</b>	none (available in other configurations)
<b>Other:</b>	Sensors:Light SensorProximity SensorG-sensorDigital Compass
<b>Battery:</b>	3900 mAh Li-Ion (1S2P)5V/1A AdapterUSB Adapter
<b>Working time on battery:</b>	12-15hr (Backlight at 10% duty cycle, default level, idle)
<b>Fast battery replacement ability:</b>	Tak
<b>HotSwap battery:</b>	No
<b>LAN:</b>	-----
<b>WLAN:</b>	Yes - 802.11 a/b/g/n
<b>Bluetooth:</b>	Yes - Bluetooth V2.1+EDR
<b>WAN:</b>	Yes - 3.75G
<b>GPS:</b>	Yes - Built-in
<b>Camera:</b>	Front: 2MpxRear: 5Mpx + LED + Autofocus
<b>In/Out:</b>	1x - Micro USB : 1x - SIM : 1x - Micro SD
<b>Optional accessories:</b>	1D/2D Barcode scannerRFIDCar holderCar chargerOptional warranty up to 3 years
<b>Docking station connector:</b>	No
<b>VESA standard – holders and mounts support:</b>	No
<b>COM port:</b>	No
<b>Magnetic card reader (MSR):</b>	No
<b>Microchip card reader:</b>	No

<b>Contrast:</b>	800:1
<b>Graphics card:</b>	-----
<b>Chipset:</b>	-----
<b>BIOS:</b>	-----
<b>Casing material:</b>	plastic
<b>Flash Card Reader:</b>	microSD (max.32GB)
<b>CD/DVD:</b>	-----
<b>Audio:</b>	Built-in Microphone : Earphone : Speaker 1.2W
<b>Keyboard:</b>	No
<b>Additional Navigation Devices :</b>	Function keys:Volume - +Power buttonFunction button
<b>Color:</b>	black-yellow
<b>Swivel Hinge:</b>	-----
<b>VGA out:</b>	-----
<b>TV Out:</b>	-----
<b>TV Tuner:</b>	-----
<b>Security:</b>	Gum case
<b>Waterproof:</b>	IP 65
<b>Sand and dust:</b>	IP 65
<b>Size:</b>	132.2 x 82 x 25.7 mm260g
<b>Fanless casing:</b>	Yes

### Product from the Archive - production finished



Founded in 1996 in Taiwan, the company Winmate achieved an excellent reputation as a manufacturer of industrial LCD displays and laptops. Due to the high position of the products in the high-tech, have won many awards in tests conducted around the world.



- Android 4.1.2



- Multiple wireless communication option

- Support for RFID and 1D/2D Barcode Reader

- Robust battery

- Industry and military standards



With its Android 4.1 platform, 1D/2D scanner, RFID reader, dual cameras, sunlight-readable 4.3-inch capacitive touchscreen, and a user-replaceable battery design, the E430R rugged handheld streamlines data collection and operations in any field application.



## Specification

Processor	ARM®Cortex™ - A9 1.0Ghz
Display	4.3" (480x800) Capacitive : Multi-touch
RAM	1GB SDRAM
ROM	4GB eMMC
Connectors	Micro USB : SIM : Micro SD (max. 32GB)
Audio	Built-in Microphone : Earphone : Speaker 1.2W
Keys	Volume +/-   Power   Define button Home   Menu   ESC   Search
Battery	3900 mAh Li-Ion (1S2P)
Camera	Front: 2Mpx Rear: 5Mpx + LED
Sensors	Light, Proximity, G-Sensor, Digital Compass
Readers (optional)	RFID HF : 1D : 1D/2D : 1D
Modules	WiFi : Bluetooth V2.1 + EDR : 3G
Operating system	Android 4.1.2 (multi-language)

Refer to the "Select version for yourself" that possibility is a version of the device. To gain additional information about the product click on the "Ask about the product" or go to the contact form.



## Accessory

One difference between consumer devices and those designed for deployment in enterprise and vertical markets that's often overlooked is the availability of supporting accessories and peripherals. For consumer devices, all that's available may be a USB charging cable — definitely not a solution that would work for rugged equipment customers. Winmate knows that and offers not only a dedicated dual battery charger that shows charging level, but also a clever daisy chainable charging dock.









## Barcode Scanner

Unlike consumer smartphones that may be able to scan using their integrated cameras, professional quality devices such as E430RM2 use industrial grade scanners. Depending on the intended use, Winmate offers standard 2D scanner for indoor/outdoor use, or a Motorola 2D scanner with extended symbology support. From retail and healthcare to warehouse and logistics, Winmate E430RM2 with various options of the scan engine can boost productivity and efficiency immediately.

	1D	1D/2D
Model	Opticon MDL-1000	Motorola SE4500
Scanner type	1D (LASER)	1D (LASER)   2D (CMOS)
Codes (1D)	JAN/UPC/EAN incl. add on, Codabar/+NW-7, Code 11, Code 39, Code 93, Code 128, GS1-UPC/EAN, Code 128, Code 39, Code 93, Code 11, 128(EAN-128), GS1 DataBar (RSS), IATA, Industrial 2of5, Interleaved 2of5, ISBN-ISMN-ISSN, Interleaved 2 of 5, Discrete 2 of 5, Codabar, MSI, Chinese 2	Matrix 2of5, MSI/Plessey, S-Code, Telepen, Tri-Optic, UK/Plessey Postal code: Chinese Post, of 5, Matrix 2 of 5, Korean3 of 5, Postal codes, GS1 Korean Postal Authority
Codes (2D)	no support	QR Code, Data Matrix, PDF417, Maxicode, Aztec





## RFID (optional)

RFID technology worldwide has aroused great interest. They are expected to solve the many problems with fast and unmistakable identification of people and equipment. Its development is more turbulent than being gradually implemented barcodes. RFID technology is cheap, reliable and versatile. RFID (Radio-Frequency Identification) is a technology used to identify objects and flow control products. Reading of information from the special tags that are attached to objects (but not only, because RFID is also applicable to the identification of the animals and even humans) followed by radio. Depending on the type of tag changes the amount of information that can hold as well as the maximum distance at which data can be read. RFID tags, is an alternative to bar codes - more comfortable and more efficient.

	RFID HF
Frequency	13.56 Mhz
ISO 15693	TI HF-I Plus TI HF-I Pro NXPI-Code SLI
ISO 14443-A	NXP Mifare_One (S50_4byte) NXP Mifare_One (S50_7byte) NXP Mifare_One (S70_4byte) NXP Mifare_UltraLight NXP Mifare_UltraLight C
ISO 18092(R/W)	SONY Felica Lite s SONY Felica Lite



## Modules and Wireless Networks

RFID HF	13.56Mhz
WiFi	802.11 a/b/g/n
Bluetooth	Bluetooth Class 2.1 + EDR
GPS	Wbudowany (u-blox NEO-6Q)

3G

2100/900MHz

[go top...](#)



In addition to standard Bluetooth and Wi-Fi, the E430R handheld offers optional GPS and 3G asset tracking and real-time data transfer. Whether indoor or outdoor, the E430R handheld provides a wide of robust communications options.

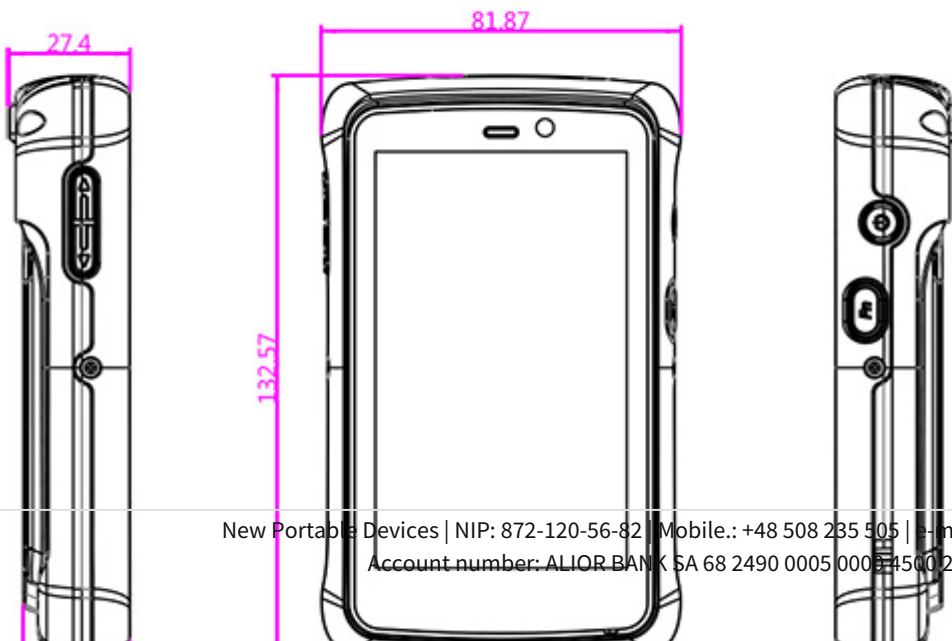
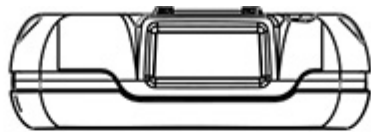



Featuring a user replaceable battery design with simple latch system, E430R handheld can support continual operation on the field without down time. The replaceable battery also features high capacity at 3900mAh for extended use.

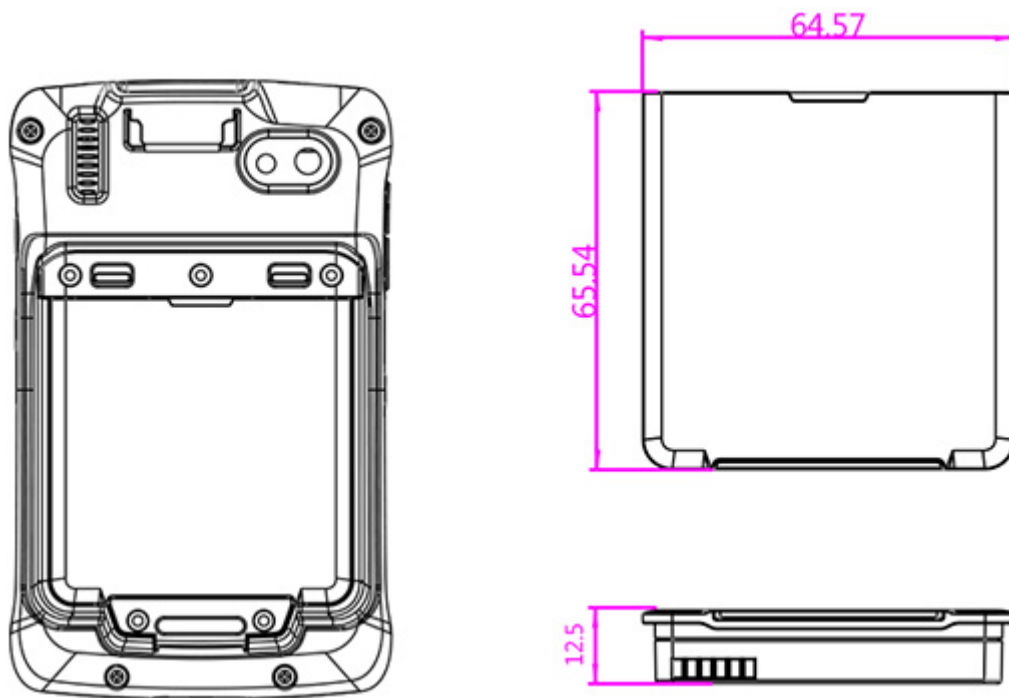

## Standards

Operating temperature	-30°C -- +60°C
Storage temperature	-40°C -- +70°C
Humidity	95% non-condensation
Dust	IP6x (dust)
Water	IPx6 (water)
Vibration	MIL-STD-810G M514.6
Drop	MIL-STD-810G Method 516.6, 4 ft, Free to concrete
Regulatory	CE, FCC, UL, CCC

[go top...](#)



[mobilator.pl](http://mobilator.pl)

## Odporność sprzętowa IP65

Sealed to IP65, the E430R handheld is built to withstand harsh environments, protected against water and dust. Compliant with MIL-STD-810G, it can operate in extreme temperatures ranging from -30°C to 60°C (-22F to 140F) and endure shock, vibration and 4-foot drops.

**The first digit [x]**  
Protection against solid objects

Complete protection against contact, Protection from infiltration of dust

6



**The second digits [y]**  
Protection against liquids

5 Protection from water projected from a nozzle

[go top...](#)

## Hardware configuration

If none of the available configuration does not interest you, you can always suggest your option components. Submit your suggestion using the contact form - up to 2 working days you will receive a valuation of the desired configuration. Remember to carefully specify each parameter and accessories.



	E430RM2-3G	E430RM2-3BL	E430RM2-3B2	E430RM2-3HF
<b>WIFI</b>	✓	✓	✓	✓
<b>Bluetooth</b>	✓	✓	✓	✓
<b>Cameras</b>	✓	✓	✓	✓
IP65	✓	✓	✓	✓
GPS	✓	✓	✓	✓
3G	✓	✓	✓	✓
1D (LASER)	-	✓	✓	-
2D (CMOS)	-	-	✓	-
RFID HF	-	-	-	✓

[more photos](#) in the "Photo Gallery" ...

[specification](#) of this version is available in the "Technical data" ...