



Mobitouch 101A-LF v.1 - Durable operator panels for use in devices with WiFi, 125 kHz RFID and a 10.1-inch surface

|                                 |                                       |
|---------------------------------|---------------------------------------|
| <b>Category:</b>                | Industrial Panel PC Computers         |
| <b>Manufacturer:</b>            | Mobikator                             |
| <b>Supported OS:</b>            | Android 12                            |
| <b>Installed OS:</b>            | Android 12                            |
| <b>Screen size:</b>             | 10.1 inch                             |
| <b>Resolution:</b>              | 800x1280                              |
| <b>Aspect ratio:</b>            | 16:10                                 |
| <b>Brightness:</b>              | 300 cd/m2                             |
| <b>Touchscreen:</b>             | No                                    |
| <b>CPU Support:</b>             | RK3568                                |
| <b>Installed CPU:</b>           | RK3568                                |
| <b>Graphic Card:</b>            | Integrated graphics Intel HD Graphics |
| <b>Storage (HDD) Support:</b>   | eMMC                                  |
| <b>Installed Storage (HDD):</b> | 64GB eMMC                             |
| <b>Memory Support:</b>          | DDR4                                  |
| <b>Installed Memory:</b>        | 4GB                                   |

|   |   |
|---|---|
| <b>IP Norm:</b>                                   | -----   |
| <b>IP Level (front panel):</b>                    | IP65  |
| <b>IP Level (back panel):</b>                     | -----   |
| <b>Temp:</b>                                      | -10 °C to 60 °C   |
| <b>Storage Temp:</b>                              | -20 °C to 70 °C   |
| <b>Humidity:</b>                                  | 5% - 95% Non-Condensing   |
| <b>Anti-shock:</b>                                | ----  |
| <b>Anti-vibration:</b>                            | ----  |
| <b>Barcode reader:</b>                            | EM-23 FUIJAN  |
| <b>RFID scanner (reader):</b>                     | LF (125 kHz) + HF (13,56 MHz - ISO14443A/B)                                     |
| <b>Others:</b>                                    | Color: Silver   |
| <b>LAN:</b>                                       | 1xRealtek RTL 8111E Gigabit Ethernet  |
| <b>Wireless LAN card:</b>                         | Yes   |
| <b>3G:</b>  | -----   |
| <b>4G LTE:</b>                                    | No  |
| <b>Bluetooth:</b>                                 | Yes   |
| <b>GPS:</b>                                       | No  |
| <b>Ports - rear panel:</b>                        | Phoenix terminal   RS232   2xUSB 3.0   RJ-45 LAN   HDMI   UBOOT   SIM   TF   DC |
| <b>Ports - front panel:</b>                       | -----   |
| <b>Ports - left panel:</b>                        | -----   |
| <b>Ports - right panel:</b>                       | -----   |
| <b>Expansion:</b>                                 | 2x speaker   Camera HD  |
| <b>Power:</b>                                     | DC-12V  |
| <b>Power Consumption:</b>                         | 20-30 w   |
| <b>Watch Dog Timer:</b>                           | Tak   |
| <b>Mounting VESA:</b>                             | 75 x 75 mm   100 x 100 mm   |
| <b>Folding Bracket (for office type working):</b> | Option  |
| <b>Chipset:</b>                                   | AMD   |

|  |                       |
|--|-----------------------|
| <b>CD/DVD Drive:</b>                   | No                    |
| <b>Audio:</b>                          | Yes                   |
| <b>TV Tuner:</b>                       | No                    |
| <b>Backlight MTBF:</b>                 | Yes                   |
| <b>Contrast Ratio:</b>                 | 1000:1                |
| <b>Dual display:</b>                   | Yes                   |
| <b>Viewing Angle:</b>                  | 85/85/85/85(L/R/U/D)  |
| <b>Touch Life(contacts):</b>           | 60000-70000           |
| <b>Surface hardness (display):</b>     | 7H                    |
| <b>Color Resolution:</b>               | 16,7M                 |
| <b>Response time touch-panel (ms):</b> | 7-30 ms               |
| <b>Housing material:</b>               | Aluminium             |
| <b>Dimensions:</b>                     | 261.4 x 185.4 x 53 mm |
| <b>Fanless:</b>                        | Yes                   |
| <b>Weight:</b>                         | 1.5kg                 |

**1 978,76 zł**

net price: 1 608,75 zł



SPECIFICATION AND PARAMETERS

DISPLAY AND TOUCH

RESISTANCE AND PROTECTION

COMMUNICATION AND CONNECTORS

APPLICATION

AVAILABLE VERSIONS AND ACCESSORIES

Industrial PC panels are integrated devices consisting of a PC computer and a touch monitor. Due to their design, they can work even under severe conditions prevailing in industrial environments, such as high humidity, high dustiness, contact with water or very low or high temperatures. These panels

are characterized by high efficiency and stability of operation in all conditions.



Efficient cooling

The housing with notches used in the panel ensures good air exchange inside the device



Quick start

A modern eMMC drive will increase the speed of applications and programs and ensure quiet computer operation.



Efficient

The quad-core RK3568 improves the device's performance.



Bright Screen

The display with 250 cd/ m<sup>2</sup> brightness makes the picture much more vivid and better readable when used outside in the sun.



Wireless network

The panel can be connected to nearby wireless networks by equipping it with a Wi-Fi module



Capacitive screen\*

The capacitive screen allows precise handling and gentle on-screen movement.

\* Optional equipment, available only in specific versions of the device.

## Specifications and parameters

| Performance   |                              |
|---------------|------------------------------|
| Processor     | RK3568 (4x 2.0 GHz)          |
| Graphics card | Integrated Intel HD Graphics |

| Performance      |   |
|------------------|---|
| Operating system | Android 12  |
| RAM              | 4GB   |
| Drive            | 64GB eMMC   |
| Display          |   |
| Screen           | 10.1" 800x1280  |
| Touch screen     | No touch  |
| Brightness       | 300cd/m <sup>2</sup>  |
| Screen ratio     | 16:9  |
| View angle       | 85/85/85/85(L/R/U/D)  |
| Interfaces       |   |
| Communication    | WiFi   Bluetooth   4G *   |
| Connectors       | Phoenix terminal   RS232   2xUSB 3.0   RJ-45 LAN   HDMI   UBOOT   SIM   TF   DC |
| 2D SCANNER       | EM-23 FUJIAN  |
| RFID             | LF 125 kHz + HF 13,56 MHz   |
| Other            |   |
| Dimensions       | 261.4 x 185.4 x 53 mm   |
| Weight           | 1.5 kg  |
| Casing material  | Aluminium   |

\* Optional equipment, available only in specific versions of the device.



Detailed device specification is available in the "Technical data".

The industrial PC panel uses an efficient and energy-saving RK3568 (4x 2.0 GHz). In its interior there are four cooperating cores enabling more efficient processing of many tasks at the same time. Shared cache memory in which a multi-level hierarchy is used is dynamically allocated to each processor core depending on the load. This reduces the average access time to the main memory. Improved graphics card technology allows you to enjoy movies at full resolution and HD quality.



More photos in full resolution available in the "Gallery".

## NPU

A special type of chip designed to handle artificial intelligence tasks. It allows a device to recognize images, voice, or text more quickly, while also operating more efficiently and saving energy. The NPU enables the use of smart features without delays, which translates into a more convenient and modern everyday user experience.

## Display and touch

Amplified, metal industrial computer Mobitouch 101A-LF+2D has a water-resistant and scratch-proof 10.1" LED screen 800x1280 resolution offers good image quality, and high brightness in the 300 cd/m<sup>2</sup> range gives better color saturation and contrast and allows significantly improved visibility even in the case of incident. The display of the resistive type provides the user with a clear image and ease of use by touch.

## CAPACITIVE SCREEN (OPTION)

The capacitive screen consists of a glass coating that is covered with an insulator. Touching the surface of the touch pad with your finger causes a disturbance in the flow of electric current. This display provides very good visibility under industrial conditions. The panel can be operated with one finger or conductive material (special glove). This type of screen provides support for multi-touch technology, which is a clear convenience during work. This is due to the fact that a large number of electrodes allows accurate detection of many points of touch. You do not have to use a stronger pressure for capacitive screens, because you only need to lightly brush the screen with your finger to make the device react.

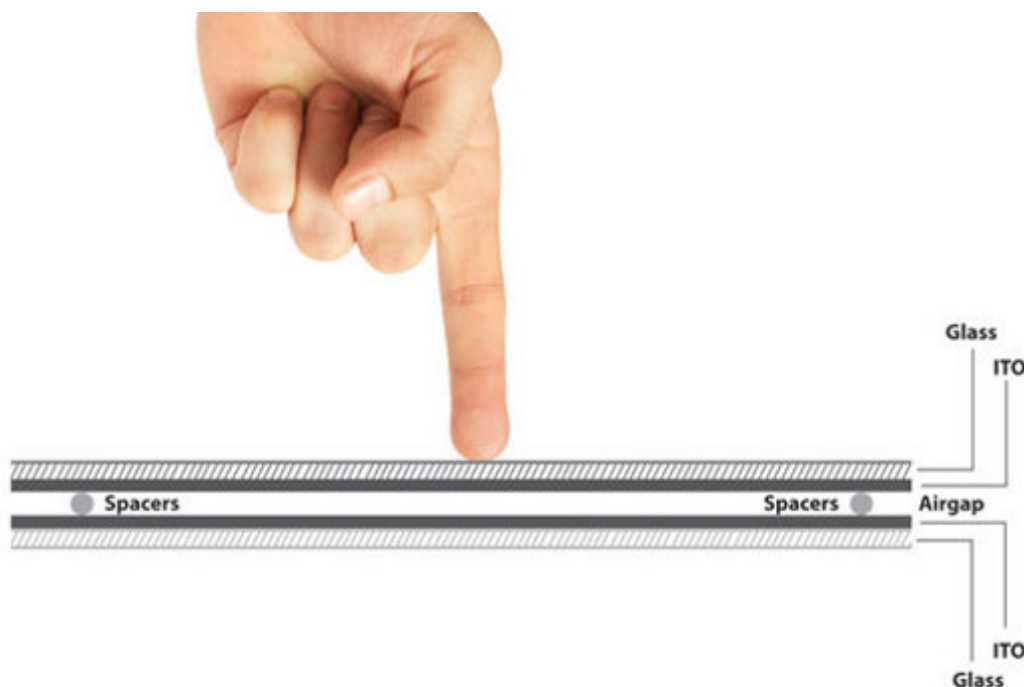

## Resistance and protection

### QUALITY OF MATERIALS

The panel PC has a good-quality metal casing. It is an important element of the cooling system thanks to specially designed cutouts that facilitate air circulation inside the housing. The overall design of the device is focused on simplicity and functionality, appreciated among professionals, as an accessory the panel can be equipped with passive cooling.



### EXTREME TEMPERATURES

PanelPC Mobitouch 101A-LF+2D is designed for continuous operation both at very low and high temperatures in the range from -10 ° C to 60 ° C. If the device is turned off, it can handle temperatures ranging from -20 ° C to 70 ° C.

In addition, the durable PanelPC is perfect for rooms with increased humidity, ensuring proper functioning even in the case of 95% relative air humidity. It is also possible to purchase additional fanless cooling.

|                      |                         |
|----------------------|-------------------------|
| <b>Work temp.</b>    | -10°C do 60°C           |
| <b>Storage temp.</b> | -20°C do 70°C           |
| <b>Humidity</b>      | 5% - 95% Non-Condensing |

## Communication and connectors

### WIRELESS WI-FI NETWORK

The dual-band Wi-Fi module provides quick access to the network wherever you can connect to secured or open Wi-Fi networks. This is a convenient solution for people who have a router at home or place of residence and a wireless network that can be used at no extra charge. The shockproof industrial panel Mobitouch 101A-LF+2D has been equipped with standards - 802.11n, which allows transfer of files at a dizzying speed of up to 150 Mb/s.

|                    |               |
|--------------------|---------------|
| <b>Standards</b>   | 802.11a/b/g/n |
| <b>Frequencies</b> | 2.4GHz        |



## BLUETOOTH COMMUNICATION

Bluetooth enables short-range wireless communication between various electronic devices, such as keyboard computer, laptop, PDA, mobile phone and many others. In the fourth version of standard, energy consumption was significantly reduced transfer and the real range of operation was increased



## 4G (OPTION)

4G technology is based on a radio network with high-speed transmission and a low incidence of do



## RFID READER

RFID is a technology used to identify objects and control the flow of products. Reading information

## CODE SCANNER

code, which is used to identify objects and control the flow of products. Reading information



## CONNECTORS AND INTERFACES

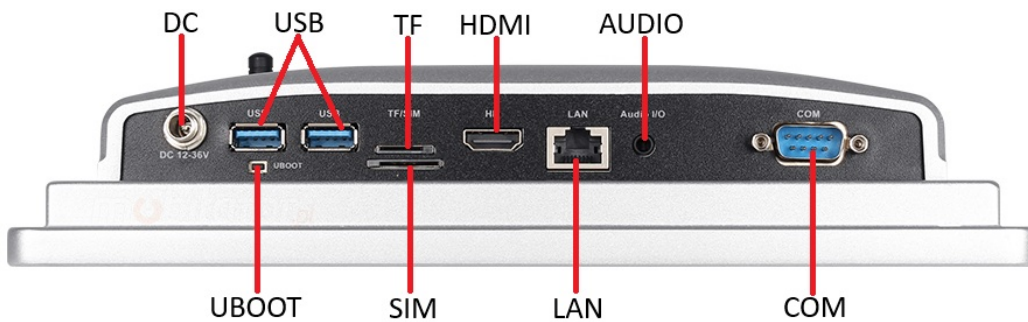

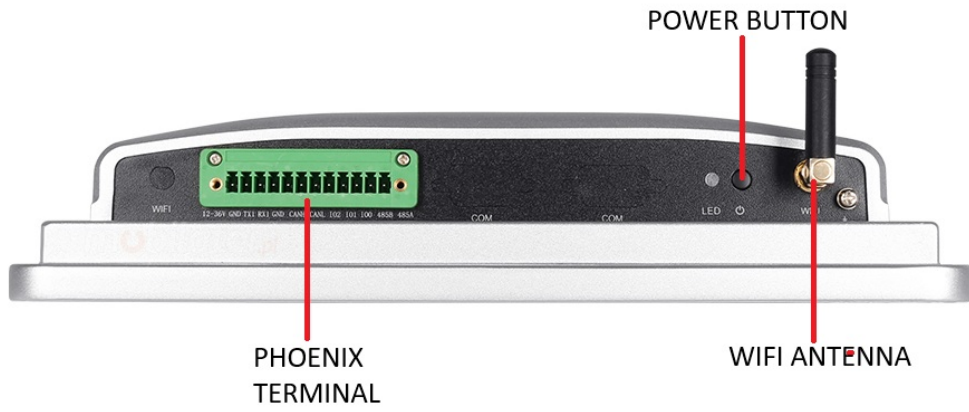

## DIMENSIONS

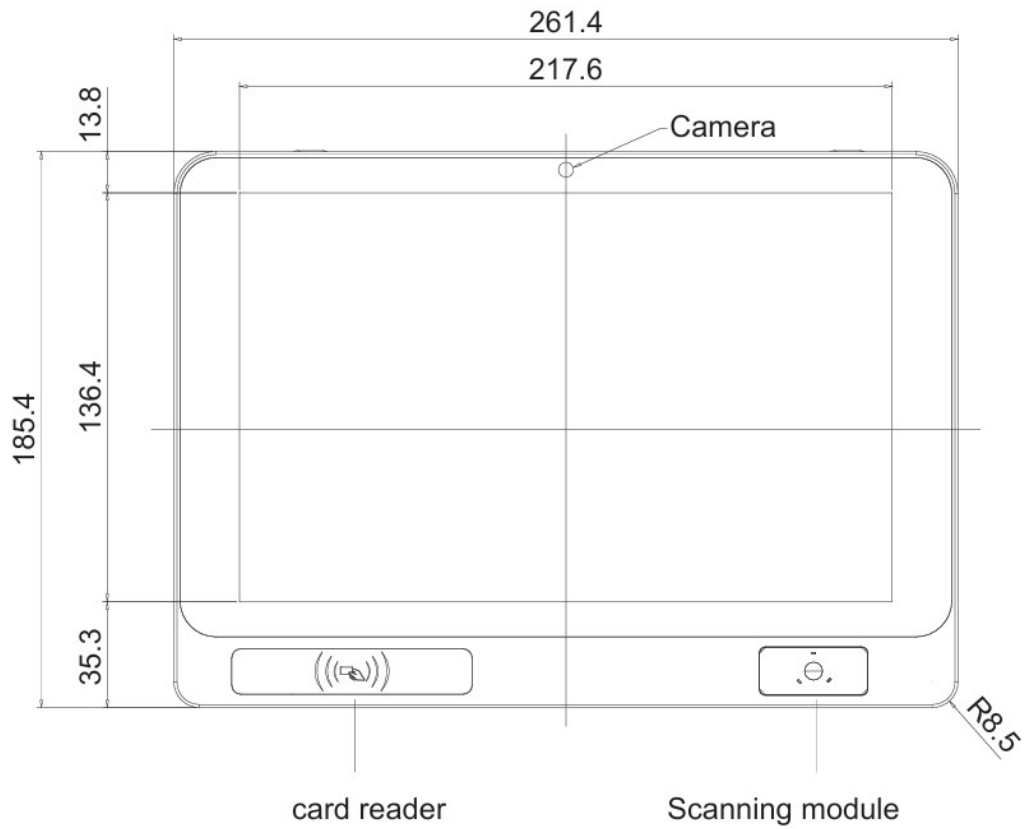

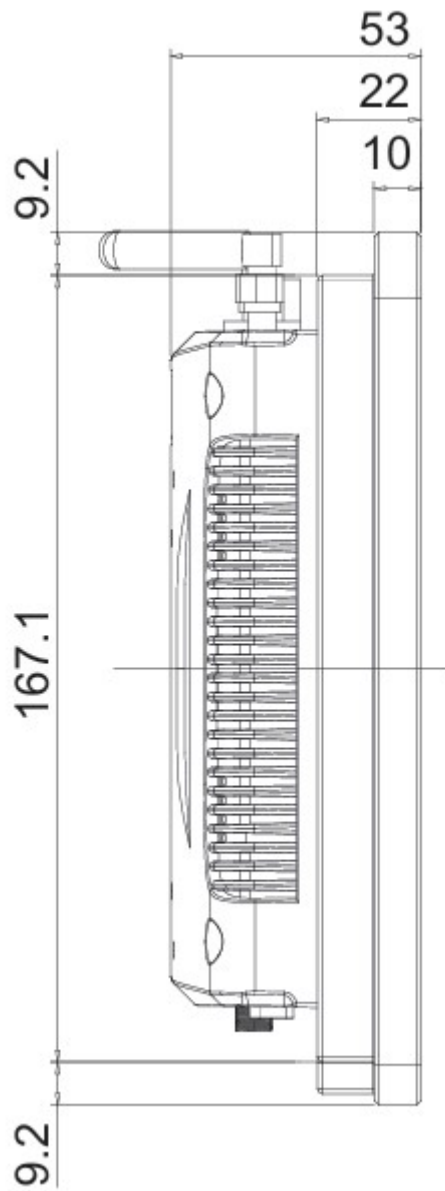

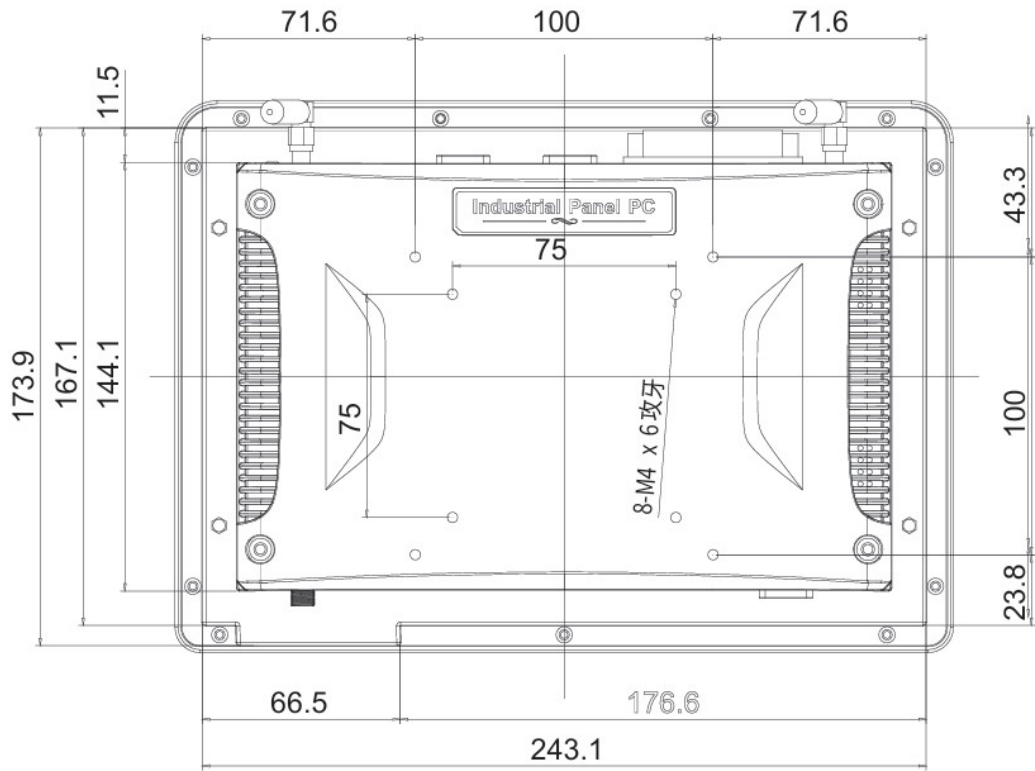

## Application

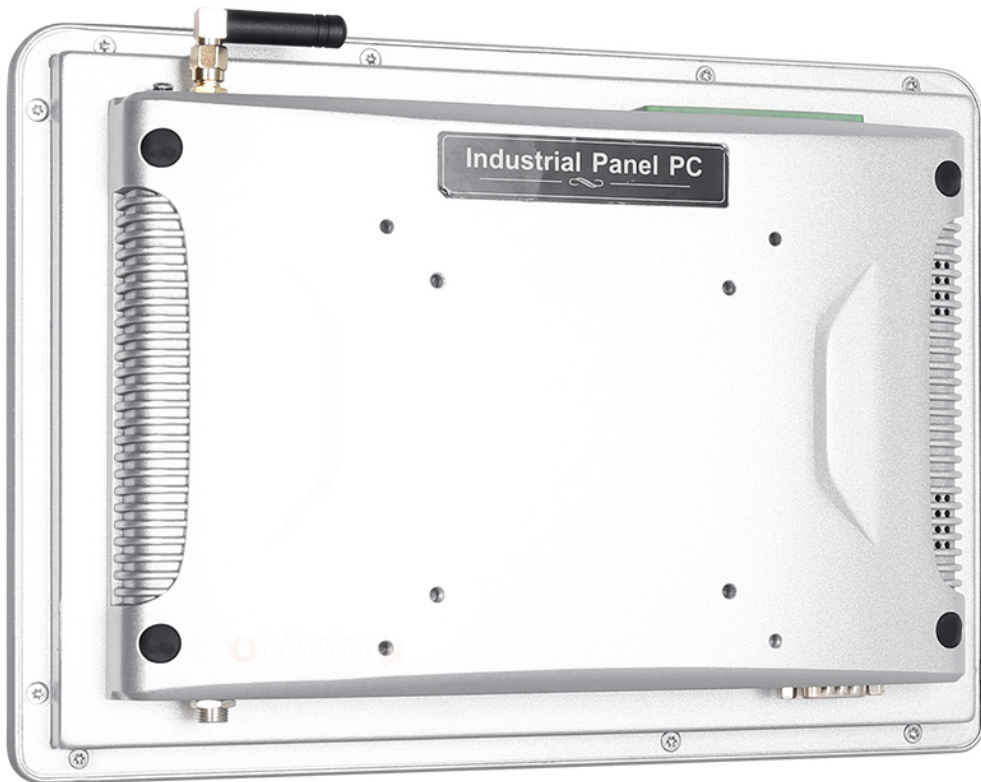

## TRADE AND SERVICES

PC Panel is widely used primarily in the commercial industry, for example for controlling the sales system, displaying product information on monitors or advertising on large screens. With the VESA holder in the housing there are many possibilities for its assembly, eg in stores (at the cash register) in factory halls, in a car delivering products, etc. It will certainly be used in all types of retail chains.

## WAREHOUSE AND MANAGEMENT

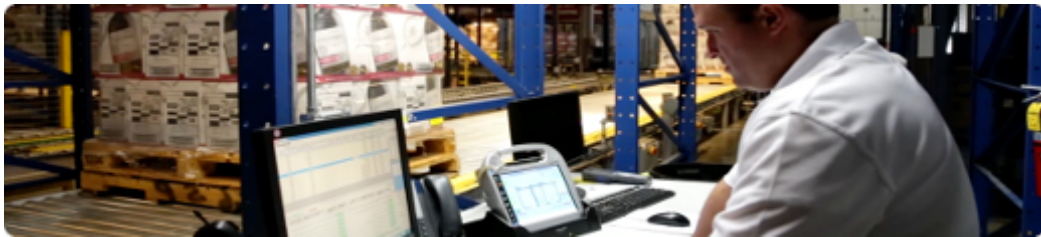

The industrial panel computer thanks to the RS232 interface can be used to connect many devices in the warehouse and facilitate their control. And its rugged housing is ideally suited to the harsh conditions prevailing in such rooms. No dust or dirt will prevent him from working, he will work without complaints even in a large dusty and dirty environment.

## TRANSPORT AND MOTORIZATION



Panel computers can be used in transport by adapting it to work on 12V power supply. Then Panel PC can be used in passenger cars, buses, trams, taxis, trains and even in airplanes. Thanks to the integrated monitor, these panels perform very well in vehicles where mobility and the small size of the device are important.

## Available versions and accessories

Industrial Panel PC Mobitouch 101A-LF+2D is offered in several versions adapted to different needs. By clicking on the number of the hardware configuration you will be redirected to the product with the parameters given in the table below. In addition, it is possible to create a configuration that is currently unavailable on the customer's request.

|                   | v.1 | v.2 | v.3 | v.4 | v.5. | v.6 | v.7 | v.8 | v.9 | v.10 |
|-------------------|-----|-----|-----|-----|------|-----|-----|-----|-----|------|
| Screen beztouch   | +   | -   | -   | -   | -    | -   | -   | -   | -   | -    |
| Capacitive screen | -   | +   | +   | +   | +    | +   | -   | -   | -   | -    |
| Screen rezystywny | -   | -   | -   | -   | -    | -   | +   | +   | +   | +    |
| 4GB RAM           | +   | +   | +   | -   | -    | -   | +   | -   | -   | -    |
| 8GB RAM           | -   | -   | -   | +   | +    | +   | -   | +   | +   | +    |

|                |   |   |   |   |   |   |   |   |   |   |
|----------------|---|---|---|---|---|---|---|---|---|---|
| 64GB eMMC      | + | + | + | - | - | - | + | - | - | - |
| 128GB eMMC     | - | - | - | + | - | - | - | + | - | - |
| 256GB eMMC     | - | - | - | - | + | + | - | - | + | + |
| 4G             | - | - | + | - | - | + | - | - | - | + |
| RFID LF 125kHz | + | + | + | + | + | + | + | + | + | + |
| Scanner 2D     | + | + | + | + | + | + | + | + | + | + |