



Mobitouch 101AH-LF+2D v.6 - Rugged (IP65) control panel with resistive screen, Android 13, 125 kHz RFID, 1D/2D scanner and BT

Category:	Industrial Panel PC Computers
Manufacturer:	Mobikator
Supported OS:	Android 13
Installed OS:	Android 13
Screen size:	10.1 inch
Resolution:	800x1280
Aspect ratio:	16:10
Brightness:	300 cd/m2
Touchscreen:	Resistive
CPU Support:	RK3588
Installed CPU:	RK3588
Graphic Card:	Integrated graphics Intel HD Graphics
Storage (HDD) Support:	eMMC
Installed Storage (HDD):	64GB eMMC
Memory Support:	DDR4
Installed Memory:	4GB

IP Norm:	-----
IP Level (front panel):	IP65
IP Level (back panel):	-----
Temp:	-10 °C to 60 °C
Storage Temp:	-20 °C to 70 °C
Humidity:	5% - 95% Non-Condensing
Anti-shock:	----
Anti-vibration:	----
Barcode reader:	EM-23 FUIJAN
RFID scanner (reader):	LF (125 kHz) + HF (13,56 MHz - ISO14443A/B)
Others:	Color: Silver
LAN:	1xRealtek RTL 8111E Gigabit Ethernet
Wireless LAN card:	Yes
3G:	-----
4G LTE:	No
Bluetooth:	Yes
GPS:	No
Ports - rear panel:	Phoenix terminal RS232 2xUSB 3.0 RJ-45 LAN HDMI UBOOT SIM TF DC
Ports - front panel:	-----
Ports - left panel:	-----
Ports - right panel:	-----
Expansion:	2x speaker
Power:	DC-12V
Power Consumption:	20-30 w
Watch Dog Timer:	Tak
Mounting VESA:	75 x 75 mm 100 x 100 mm
Folding Bracket (for office type working):	Option
Chipset:	AMD

CD/DVD Drive:	No
Audio:	Yes
TV Tuner:	No
Backlight MTBF:	Yes
Contrast Ratio:	1000:1
Dual display:	Yes
Viewing Angle:	85/85/85/85(L/R/U/D)
Touch Life(contacts):	60000-70000
Surface hardness (display):	7H
Color Resolution:	16,7M
Response time touch-panel (ms):	7-30 ms
Housing material:	Aluminium
Dimensions:	261.4 x 185.4 x 53 mm
Fanless:	Yes
Weight:	1.5kg

3 090,38 zł

net price: 2 512,50 zł



SPECIFICATION AND PARAMETERS

DISPLAY AND TOUCH

RESISTANCE AND PROTECTION

COMMUNICATION AND CONNECTORS

APPLICATION

AVAILABLE VERSIONS AND ACCESSORIES

Industrial PC panels are integrated devices consisting of a PC computer and a touch monitor. Due to their design, they can work even under severe conditions prevailing in industrial environments, such as high humidity, high dustiness, contact with water or very low or high temperatures. These panels

are characterized by high efficiency and stability of operation in all conditions.



Efficient cooling

The housing with notches used in the panel ensures good air exchange inside the device



Quick start

A modern eMMC drive will increase the speed of applications and programs and ensure quiet computer operation.



Efficient

The quad-core RK3568 improves the device's performance.



Bright Screen

The display with 250 cd/ m² brightness makes the picture much more vivid and better readable when used outside in the sun.



Wireless network

The panel can be connected to nearby wireless networks by equipping it with a Wi-Fi module



Resistive screen

The resistive screen allows precise handling and gentle on-screen movement.

Specifications and parameters

Performance	
Processor	RK3588 (8x 2.4 GHz)
Graphics card	Integrated Intel HD Graphics
Operating system	Android 13

Performance	
RAM	4GB
Drive	64GB eMMC
Display	
Screen	10.1" 800x1280
Touch screen	Resistive
Brightness	300cd/m ²
Screen ratio	16:9
View angle	85/85/85/85(L/R/U/D)
Interfaces	
Communication	WiFi Bluetooth 4G *
Connectors	Phoenix terminal RS232 2xUSB 3.0 RJ-45 LAN HDMI UBOOT SIM TF DC
2D SCANNER	EM-23 FUJIAN
RFID	LF 125 kHz + HF 13,56 MHz
Other	
Dimensions	261.4 x 185.4 x 53 mm
Weight	1.5 kg
Casing material	Aluminium

* Optional equipment, available only in specific versions of the device.



Detailed device specification is available in the "Technical data".

The industrial PC panel uses an efficient and energy-saving RK3588 (8x 2.4 GHz). In its interior there are eight cooperating cores enabling more efficient processing of many tasks at the same time. Shared cache memory in which a multi-level hierarchy is used is dynamically allocated to each processor core depending on the load. This reduces the average access time to the main memory. Improved graphics card technology allows you to enjoy movies at full resolution and HD quality.



More photos in full resolution available in the "Gallery".

NPU

A special type of chip designed to handle artificial intelligence tasks. It allows a device to recognize images, voice, or text more quickly, while also operating more efficiently and saving energy. The NPU enables the use of smart features without delays, which translates into a more convenient and modern everyday user experience.

Display and touch

Amplified, metal industrial computer Mobitouch 101AH-LF+2D has a water-resistant and scratch-proof 10.1" LED screen 800x1280 resolution offers good image quality, and high brightness in the 300 cd/m² range gives better color saturation and contrast and allows significantly improved visibility even in the case of incident The display of the resistive type provides the user with a clear image and ease of use by touch.

RESISTIVE SCREEN

The barcode reader allows you to read, decode, and transfer data stored in a barcode to a computer.

Resistance and protection

QUALITY OF MATERIALS

The panel PC has a good-quality metal casing. It is an important element of the cooling system thanks to specially designed cutouts that facilitate air circulation inside the housing. The overall design of the device is focused on simplicity and functionality, appreciated among professionals, as an accessory the panel can be equipped with passive cooling.



EXTREME TEMPERATURES

PanelPC Mobitouch 101AH-LF+2D is designed for continuous operation both at very low and high temperatures in the range from -10 ° C to 60 ° C. If the device is turned off, it can handle temperatures ranging from -20 ° C to 70 ° C. In addition, the durable PanelPC is perfect for rooms with increased humidity, ensuring proper functioning even in the case of 95% relative air humidity. It is also possible to purchase additional fanless cooling.

Work temp.	-10°C do 60°C
Storage temp.	-20°C do 70°C
Humidity	5% - 95% Non-Condensing

Communication and connectors

WIRELESS WI-FI NETWORK

The dual-band Wi-Fi module provides quick access to the network wherever you can connect to secured or open Wi-Fi networks. This is a convenient solution for people who have a router at home or place of residence and a wireless network that can be used at no extra charge. The shockproof industrial panel Mobitouch 101AH-LF+2D has been equipped with standards - 802.11n, which allows transfer of files at a dizzying speed of up to 150 Mb/s.

Standards	802.11a/b/g/n
Frequencies	2.4GHz



BLUETOOTH COMMUNICATION

Bluetooth enables short-range wireless communication between various electronic devices, such as keyboard computer, laptop, PDA, mobile phone and many others. In the fourth version of standard, energy consumption was significantly reduced transfer and the real range of operation was increased



4G (OPTION)

4G technology is based on a radio network with high-speed transmission and a low incidence of do



RFID READER

RFID is a technology used to identify objects and control the flow of products. Reading information

CODE SCANNER

cb



CONNECTORS AND INTERFACES

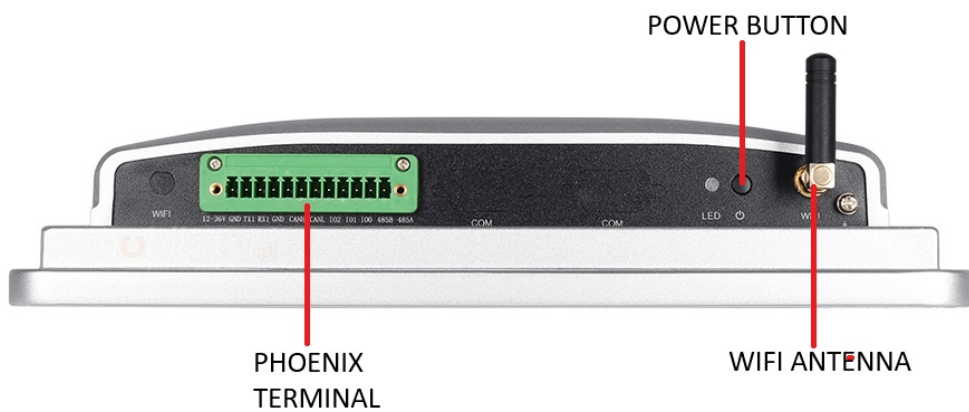
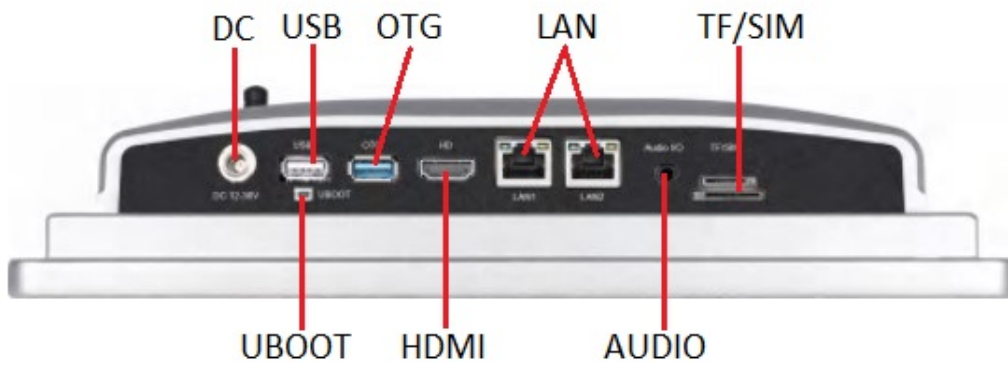

DIMENSIONS

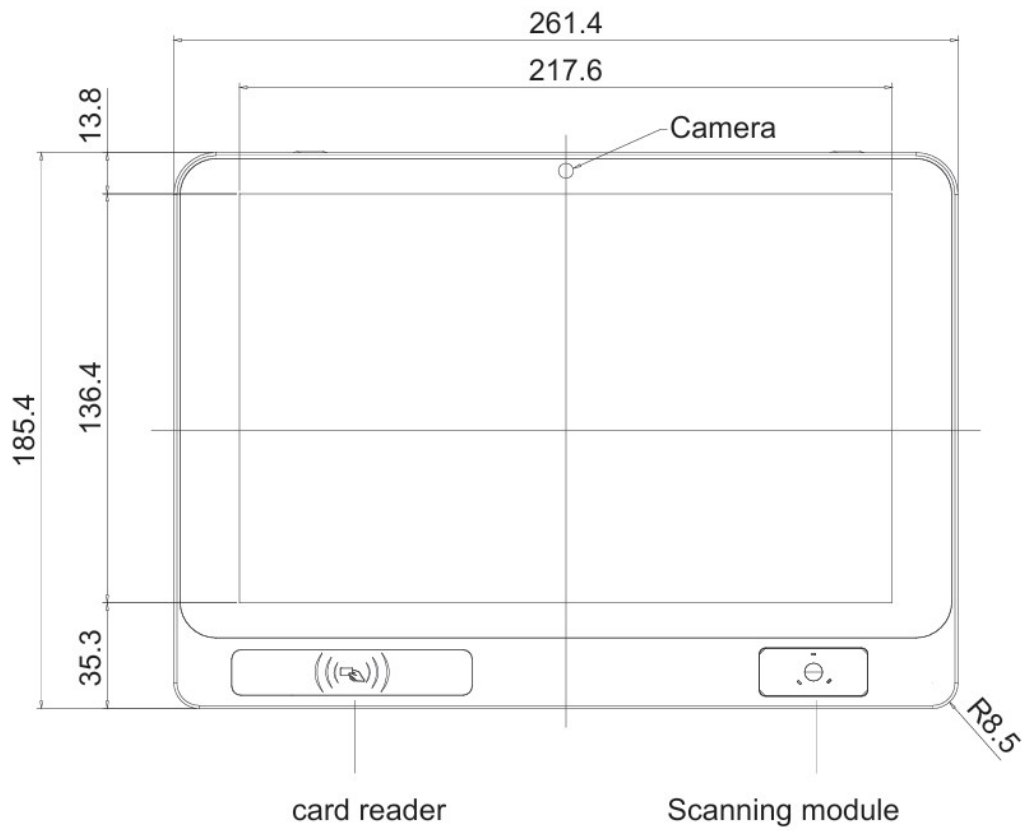

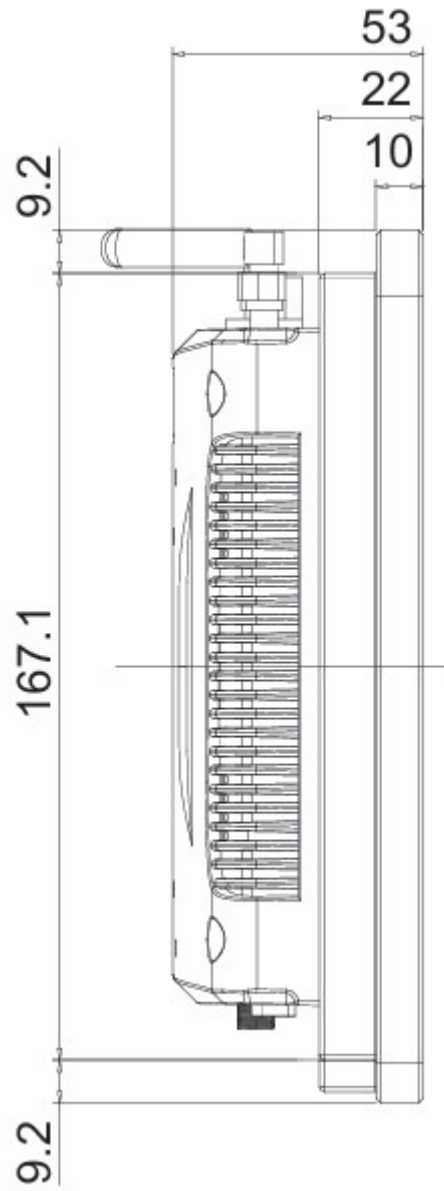

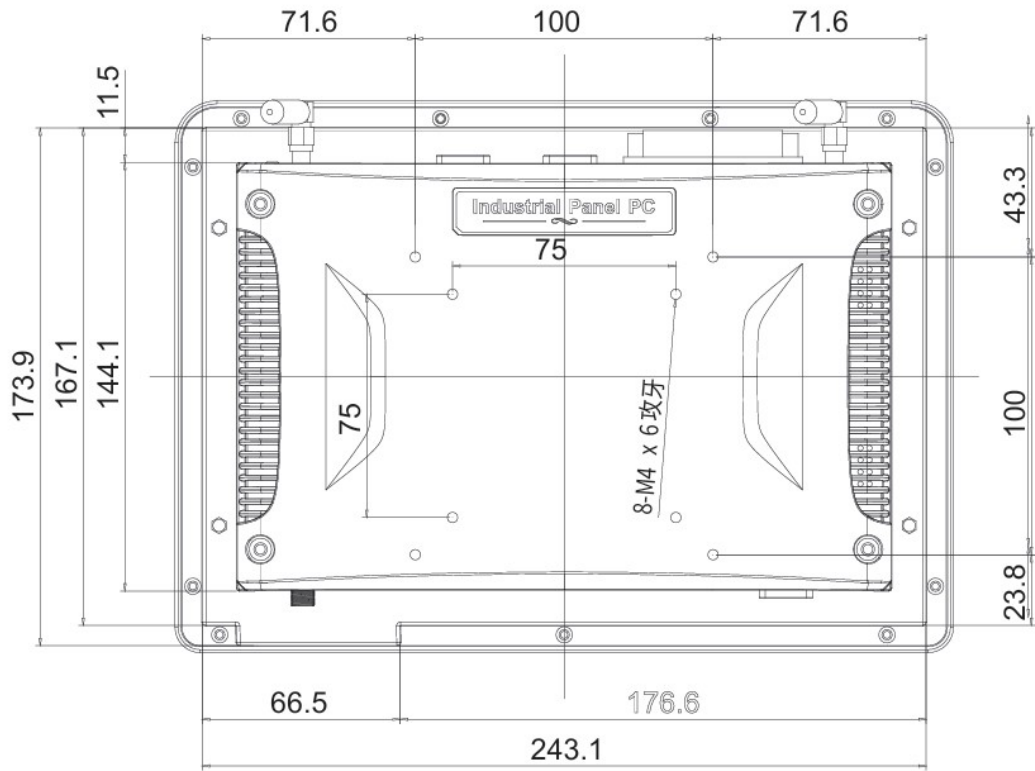

Application

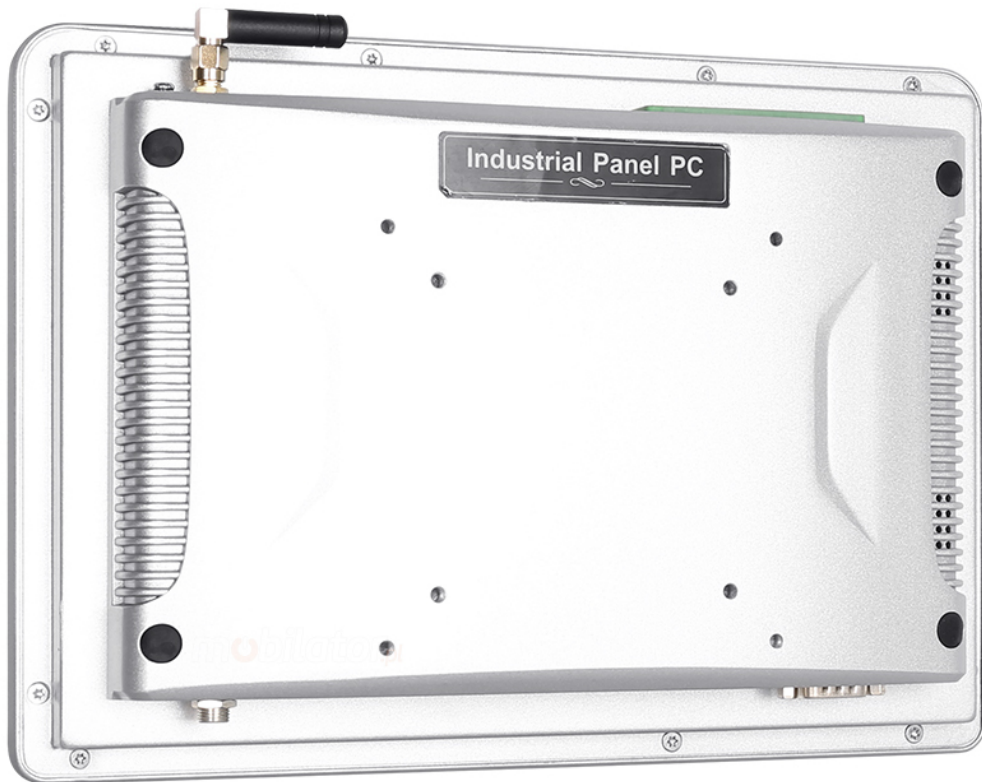

TRADE AND SERVICES

PC Panel is widely used primarily in the commercial industry, for example for controlling the sales system, displaying product information on monitors or advertising on large screens. With the VESA holder in the housing there are many possibilities for its assembly, eg in stores (at the cash register) in factory halls, in a car delivering products, etc. It will certainly be used in all types of retail chains.

WAREHOUSE AND MANAGEMENT

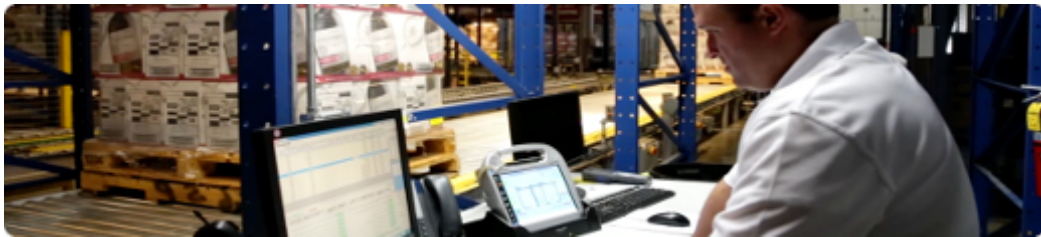

The industrial panel computer thanks to the RS232 interface can be used to connect many devices in the warehouse and facilitate their control. And its rugged housing is ideally suited to the harsh conditions prevailing in such rooms. No dust or dirt will prevent him from working, he will work without complaints even in a large dusty and dirty environment.

TRANSPORT AND MOTORIZATION



Panel computers can be used in transport by adapting it to work on 12V power supply. Then Panel PC can be used in passenger cars, buses, trams, taxis, trains and even in airplanes. Thanks to the integrated monitor, these panels perform very well in vehicles where mobility and the small size of the device are important.

Available versions and accessories

Industrial Panel PC Mobitouch 101AH-LF+2D is offered in several versions adapted to different needs. By clicking on the number of the hardware configuration you will be redirected to the product with the parameters given in the table below. In addition, it is possible to create a configuration that is currently unavailable on the customer's request.

	v.1	v.2	v.3	v.4	v.5	v.6	v.7	v.8
Screen beztouch	+	–	–	–	–	–	–	–
Capacitive screen	–	+	+	+	+	–	–	–
Screen rezystywny	–	–	–	–	–	+	+	+
4GB RAM	+	+	+	–	–	+	–	–
8GB RAM	–	–	–	+	+	–	+	+

64GB eMMC	+	+	+	-	-	+	-	-
256GB eMMC	-	-	-	+	+	-	+	+
4G	-	-	+	-	+	-	-	+
Scanner 2D EM23	+	+	+	+	+	+	+	+
LF RFID 125kHz	+	+	+	+	+	+	+	+