



Reinforced Resistant Industrial Panel PC
IP67 QBOX 15 v.4.1

Category:	Industrial Panel PC Computers
Manufacturer:	Mobikator
Supported OS:	Windows 7/8.1/10 Linux
Installed OS:	-----
Screen size:	15"
Resolution:	1024 x 768
Aspect ratio:	-----
Brightness:	300 cd/m2
Touchscreen:	Resistive
CPU Support:	Intel Celeron J1900 (4x 2GHz)
Installed CPU:	Intel Celeron J1900 (4x 2GHz)
Graphic Card:	Intel HD Graphics
Storage (HDD) Support:	32GB/64GB/128GB/256GB SSD 500GB HDD
Installed Storage (HDD):	128GB SSD
Memory Support:	up to 8GB DDR3
Installed Memory:	8GB
IP Norm:	IP67
IP Level (front panel):	IP67
IP Level (back panel):	IP67

Temp:	0°C ~ 60°C
Storage Temp:	-20°C ~ 80°C
Humidity:	10%~ 95%
Anti-shock:	-----
Anti-vibration:	-----
Barcode reader:	-----
RFID scanner (reader):	-----
Others:	Housing color: Silver
LAN:	Intel 82583V
Wireless LAN card:	Yes
3G:	No
Bluetooth:	No
GPS:	No
Ports - rear panel:	1x RS-232 4x USB 2.0 1x VGA 1x LAN 1x DC-in
Ports - front panel:	-----
Ports - left panel:	-----
Ports - right panel:	-----
Expansion:	-----
Power:	12V DC-in
Power Consumption:	-----
Watch Dog Timer:	-----
Mounting VESA:	Yes
Folding Bracket (for office type working):	-----
Chipset:	SOC
CD/DVD Drive:	-----
Audio:	RTL ALC662
TV Tuner:	-----
Backlight MTBF:	LED

Contrast Ratio:	1000:1
Dual display:	Nie
Viewing Angle:	85/85/85/85
Touch Life(contacts):	-----
Surface hardness (display):	3H
Color Resolution:	16.2 M
Housing material:	Stainless steel
Dimensions:	366mm x 290mm x 52mm
Fanless:	Yes
Weight:	3kg

6 392,93 zł

net price: 5 197,50 zł



Specification and parameters

Display and touch

Resistance and protection

Communication and connectors

Application

Available versions and accessories

Industrial PC panels are integrated devices consisting of a PC computer and a touch monitor. Due to their design, they can work even under severe conditions prevailing in industrial environments, such as high humidity, high dustiness, contact with water or very low or high temperatures. These panels are characterized by high efficiency and stability of operation in all conditions.



Wodoodporny

The IPX7 water-resistance standard on the front panel guarantees protection of the device for contact with water.

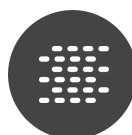

Dustproof

The dustproof IP6X standard on the front panel protects the panel against dust and access to hazardous parts.



Efficient



Bright Screen

The quad-core Intel Celeron processor supported by 8GB of RAM improves the device's performance.

The display with 300cd/ m² brightness makes the picture much more vivid and better readable when used outside in the sun.



Wireless network

The panel can be connected to nearby wireless networks by equipping it with an optional Wi-Fi module.



Resistive screen

The resistive screen allows you to freely use the touch screen of the PC panel in gloves or with a stylus.

Specifications and parameters

Performance	
Processor	Intel Celeron J1900 (4x 2GHz)
Graphics card	Intel HD Graphics

Performance	
Operating system	Windows 7/8/10 Linux
RAM	8GB DDR3
Drive	128GB SSD
Display	
Screen	15" (1024x768)
Touch screen	Resistive
Brightness	300cd/m ²
Contrast	1000:1
View angle	85/85/85/85
Hardness	3H
Interfaces	
Communication	Wi-Fi *
Connectors	VGA RJ45 4x USB 2.0 RS232 DC 12V
Memory card	No
SIM card	No
Other	
Protection	IP67
Dimensions	366mm x 290mm x 52mm
Weight	3kg

* Optional equipment, available only in specific versions of the device.



Detailed device specification is available in the "Technical data" tab.

The dust-proof industrial PC panel uses an efficient and energy-saving Intel Celeron J1900 processor. In its interior there are two cooperating cores enabling more efficient processing of many tasks at the same time. Shared cache memory in which a multi-level hierarchy is used is dynamically allocated to each processor core depending on the load. This reduces the average access time to the main memory. Improved graphics card technology allows you to enjoy movies at full resolution and HD quality.





More photos in full resolution available in the "Gallery" tab.

Display and touch

Amplified, waterproof industrial computer QBOX 15 has a water-resistant and scratch-proof 15" LED screen 1024x768 resolution offers good image quality, and high brightness in the 300 cd/m² range gives better color saturation and contrast and allows significantly improved visibility even in the case of incident. The display of the resistive type provides the user with a clear image and ease of use by touch.

RESISTIVE SCREEN

In the resistive screen, the sensitive surface is made of two plastic plates. The plate on the surface is made of thin and scratch-resistant plastic. It is also covered with a thin layer of conductive materials placed on the bottom of the screen. Under the top glass (i.e. below the conductive material) is a second plastic plate. Both tiles have no contact with each other until the user of the device has pressed the screen with a finger or stylus. Then there is contact between slightly separated screens. As a result of their contact, a short-circuit is created, which by measuring the vertical and horizontal resistance is converted into data indicating the processor's contact point.

Resistance and protection

PROTECTION STANDARD **IP65**

IP norm (International Protection Rating) determines the degree of protection provided by the housing of an electrical device against such factors as: access to dangerous parts inside the housing, penetration of foreign solids and splashing or immersion. The first characteristic number means that the housing protects people against access to dangerous parts located inside the device, and at the same time provides protection against penetration of foreign solids. The second characteristic digit means that the housing provides protection against the effects of water penetration.

IP6X	Protection against access to dangerous parts with wire. Dustproof protection.
IPX7	Ingress of water in harmful quantity shall not be possible when the enclosure is immersed in water under defined conditions.

EXTREME TEMPERATURES

PanelPC QBOX 15 is adapted for continuous operation in both very low and high temperatures in the range from 0 ° C to 60 ° C. If the device is switched off, it can already handle temperatures between -20 ° C and 80 ° C. In addition,

the durable PanelPC is perfect for rooms with increased humidity, ensuring proper functioning even in the case of 95% relative humidity.

Work temp.	0°C do 60°C
Storage temp.	-20°C do 80°C
Humidity	10% - 95%

Komunikacja i złącza

Optional equipment

WIRELESS WI-FI NETWORK

The dual-band Wi-Fi module provides quick access to the network wherever you can connect to secured or open Wi-Fi networks. This is a convenient solution for people who have a router at home or place of residence and a wireless network that can be used at no extra charge. The shockproof industrial panel QBOX 15 has been equipped with standards - 802.11n, which allows transfer of files at a dizzying speed of up to 150 Mb/s.

Standards	802.11a/b/g/n
Frequencies	2.4GHz 5GHz

CONNECTORS AND INTERFACES

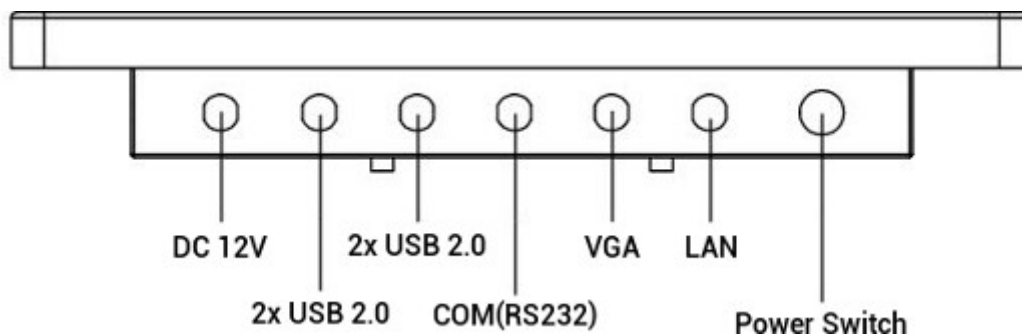

Application

TRADE AND SERVICES

Waterproof and dustproof PC Panel is widely used primarily in the commercial industry, for example for controlling the sales system, displaying product information on monitors or advertising on large screens. With the VESA holder in the housing there are many possibilities for its assembly, eg in stores (at the cash register) in factory halls, in a car delivering products, etc. It will certainly be used in all types of retail chains.

WAREHOUSE AND MANAGEMENT

The industrial panel computer thanks to the RS232 interface can be used to connect many devices in the warehouse and facilitate their control. And its rugged housing is ideally suited to the harsh conditions prevailing in such rooms. No dust or dirt will prevent him from working, he will work without complaints even in a large dusty and dirty environment.

TRANSPORT AND **MOTORIZATION**

Panel computers can be used in transport by adapting it to work on 12V power supply. Then Panel PC can be used in passenger cars, buses, trams, taxis, trains and even in airplanes. Thanks to the integrated monitor, these panels perform very well in vehicles where mobility and the small size of the device are important.

Available versions and accessories

Industrial industrial computer QBOX 15 is offered in several versions adapted to different needs. By clicking on the number of the hardware configuration you will be redirected to the product with the parameters given in the table below. In addition, it is possible to create a configuration that is currently unavailable on the customer's request.

	v.1	v.2	v.3	v.4	v.5	v.3.1	v.4.1	v.5.1	v.5.2
2GB RAM	+	—	—	—	—	—	—	—	—
4GB RAM	—	+	+	+	+	+	—	—	—
8GB RAM	—	—	—	—	—	—	+	+	+
32GB SSD	+	—	—	—	—	—	—	—	—

64GB SSD	—	+	+	—	—	—	—	—	—
128GB SSD	—	—	—	+	—	—	+	—	—
256GB SSD	—	—	—	—	+	—	—	—	—
500GB HDD	—	—	—	—	—	+	—	+	+
Wi-Fi	—	—	+	+	+	+	+	+	+